

7th Edition

Premium Gate Hardware



GATEMATE

FENCEMATE



WELCOME

Forge Products is the sole wholesaler in Canada for GATEMATE, a British brand of quality and innovative gate hardware that has been available for 2 decades. As a leader in the gate hardware industry there are many things that set us apart...

- *Largest selection of wood gate hardware in Canada*
- *Exclusive Product Range*
- *Free shipping with low minimums*
- *Hinges available in a broad size range up to 48"*
- *An uncompromising commitment to value and quality*
- *Distribution in Canada, United States, England, Ireland, and New Zealand*

Products available from authorized distributors...

Call our customer service department at 1-877-576-1376 to locate your closest dealer or to become set up as a dealer.



GLOBAL ASSOCIATE COMPANIES



Forge
Products



Abbey
Trading



Birkdale
Sales



Amuri
Products, LTD



Birkdale
Sales



SATISFACTION GUARANTEED

We guarantee the performance and quality of every one of our products.

CONTENTS



Traditional Hardware
1-10



316 Stainless Steel
11-13



Antique Ironmongery
15-20



Security Products
21-23

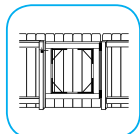

Gate Frames
25-27

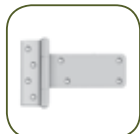

Standard Gate Components
29-36



Decking Accessories
37-40



Shed Hardware
41-45



Fieldgate Fittings
47-50



Vinyl Gate Hardware
51-53



Rope Fittings
55-56

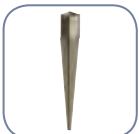

Post Support Products
57-58



Screws & Fasteners
59-60



Displays
61-64

Index **66**



This icon notes
Hot Dipped Galvanized &
Black Powder Coating



This icon notes 316
Grade Stainless Steel





Guide to GateMate Quality Finishes

Standard Black Finish

Black Polyester Powder Coating

Zinc Plate 

Base Metal / Steel 

Premium Shell



Black Polyester Powder Coating

Hot Dipped Galvanizing 

Base Metal / Steel 

Zinc (E-Galvanizing)

Zinc Plate

Base Metal / Steel 

Marine Grade 316 Stainless Steel



Solid 316 Stainless Steel Self Color

Hot Dipped Galvanizing

Hot Dipped Galvanizing

Base Metal / Steel 

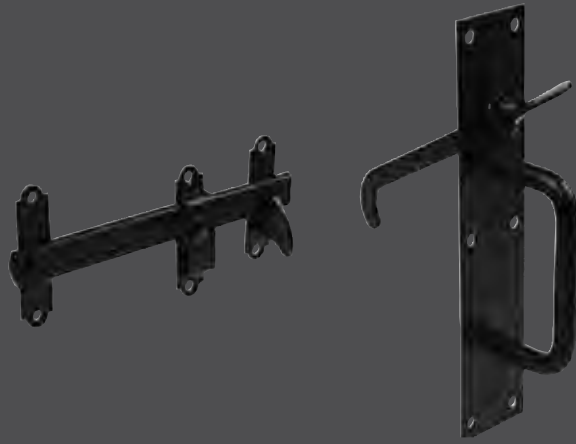

Traditional Hardware

This section features a comprehensive range of gate and door hardware to enhance custom gates. Other uses include sheds, barn doors, and farm/ag applications.



GATEMATE[®]

HINGES



STRONG TEE HINGES



SIZE INS (MM)	FINISH	PAIRS PER BOX	CODE
12" (300)	Galvanized	5	503 300 1
12" (300)	Black	5	503 300 3
18" (450)	Galvanized	5	503 450 1
18" (450)	Black	5	503 450 3
24" (600)	Galvanized	5	503 600 1
24" (600)	Black	5	503 600 3
8" (200)	316 SS Brushed Matte	5	505 200 6
8" (200)	316 SS Black	5	505 200 7
12" (300)	316 SS Brushed Matte	5	505 300 6
12" (300)	316 SS Black	5	505 300 7



CRANKED BANDS & HOOKS ON PLATES



SIZE INS (MM)	FINISH	PAIRS PER BOX	CODE
8" (200)	Galvanized	5	507 200 1
8" (200)	Black	5	507 200 3
12" (300)	Galvanized	5	507 300 1
12" (300)	Black	5	507 300 3
18" (450)	Galvanized	5	507 450 1
18" (450)	Black	5	507 450 3
18" (450)	316 SS Brushed Matte	5	507 450 6
18" (450)	316 SS Black	5	507 450 7
24" (600)	Galvanized	2	507 600 1
24" (600)	Black	2	507 600 3
24" (600)	316 SS Brushed Matte	1	507 600 6
24" (600)	316 SS Black	1	507 600 7
30" (750)	Galvanized	2	507 750 1
30" (750)	Black	2	507 750 3
36" (900)	Galvanized	2	507 900 1
36" (900)	Black	2	507 900 3



STRAIGHT BANDS & HOOKS



SIZE INS (MM)	FINISH	PAIRS PER BOX	CODE
8 x 1/2" (200)	Galvanized	5	506 201 1
8 x 1/2" (200)	Black	5	506 201 3
12 x 5/8" (300)	Galvanized	5	506 301 1
12 x 5/8" (300)	Black	5	506 301 3
18 x 3/4" (450)	Galvanized	5	506 451 1
18 x 3/4" (450)	Black	5	506 451 3
24 x 3/4" (600)	Galvanized	2	506 601 1
24 x 3/4" (600)	Black	2	506 601 3

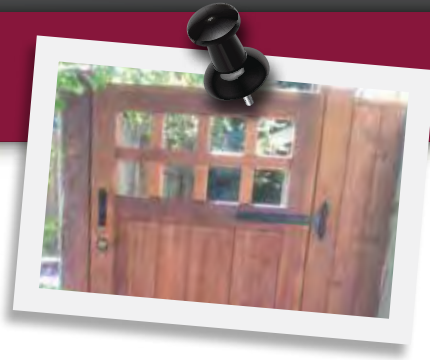

ADJUSTABLE BANDS & HOOKS ON PLATES

SIZE INS (MM)	FINISH	PAIRS PER BOX	CODE
14" (350)	Galvanized	5	508 350 1
14" (350)	Black	5	508 350 3
18" (450)	Galvanized	5	508 450 1
18" (450)	Black	5	508 450 3
18" (450)	316 SS Brushed Matte	1	508 450 6
18" (450)	316 SS Black	1	508 450 7
24" (600)	Galvanized	2	508 600 1
24" (600)	Black	2	508 600 3
24" (600)	316 SS Brushed Matte	1	508 600 6
24" (600)	316 SS Black	1	508 600 7
36" (900)	Galvanized	1	508 900 1



HEAVY REVERSIBLE HINGES

SIZE INS (MM)	FINISH	PAIRS PER BOX	CODE
7" (175)	Galvanized	5	509 175 1
7" (175)	Black	5	509 175 3
12" (300)	Galvanized	5	509 300 1
12" (300)	Black	5	509 300 3
18" (450)	Galvanized	5	509 450 1
18" (450)	Black	5	509 450 3
24" (600)	Galvanized	2	509 600 1
24" (600)	Black	2	509 600 3
30" (750)	Galvanized	2	509 750 1
30" (750)	Black	2	509 750 3
36" (900)	Galvanized	2	509 900 1
36" (900)	Black	2	509 900 3
42" (1050)	Galvanized	1	509 105 1
42" (1050)	Black	1	509 105 3



HEAVY REVERSIBLE HINGES WITH NYLON BUSHINGS

SIZE INS (MM)	FINISH	PAIRS PER BOX	CODE
12" (300)	Black	1/5	509 300 3NYL
18" (450)	Black	1/5	509 450 3NYL

NEW



TRADITIONAL HINGE FRONT

SIZE INS (MM)	FINISH	PAIRS PER BOX	CODE
12" (300)	Black	1/5	506 305 3
18" (450)	Black	1/5	506 455 3
24" (600)	Black	1/5	506 605 3

NEW



Traditional Hardware



BUTT HINGES (EUROPEAN DESIGN)

SIZE INS (MM)	FINISH	PAIRS PER BOX	CODE
2" (50)	Zinc	5	504 050 2
3" (75)	Zinc	5	504 075 2
4" (100)	Zinc	5	504 100 2
6" (150)	Zinc	5	504 150 2



CURVED RAIL HINGE KITS - HANDED

SIZE INS (MM)	FINISH	PAIRS PER BOX	HAND	CODE
12" (300)	Galvanized	5	L/H	598 000 1
12" (300)	Galvanized	5	R/H	598 001 1
12" (300)	Black	5	L/H	598 000 3
12" (300)	Black	5	R/H	598 001 3

RIGHT-HANDED OPTION SHOWN

Specify Left or Right handed kit when ordering.

PRE-PACKED BOLTS

1/2" BRENTON PADBOLTS

SIZE INS (MM)	FINISH	QTY PER BOX	CODE
4" x 1/2" (100)	Zinc	5	512 100 2
4" x 1/2" (100)	Black	5	512 100 3
6" x 1/2" (150)	Galvanized	5	512 150 1
6" x 1/2" (150)	Black	5	512 150 3
6" x 1/2" (150)	316 SS Brushed Matte	1	512 150 6
6" x 1/2" (150)	316 SS Black	1	512 150 7
8" x 1/2" (200)	Galvanized	5	512 200 1
8" x 1/2" (200)	Black	5	512 200 3



Use with padlock - see page 22. Padlockable.

5/8" HEAVY DUTY BRENTON PADBOLTS

SIZE INS (MM)	FINISH	QTY PER BOX	CODE
8" x 5/8" (200)	316 SS Brushed Matte	1	513 200 6
8" x 5/8" (200)	316 SS Black	1	513 200 7
10" x 5/8" (250)	Galvanized	5	513 250 1
12" x 5/8" (300)	Galvanized	5	513 300 1

Use with padlock - see page 22. Padlockable.

HEAVY DUTY
DUMPSTER
ENCLOSER



HEAVY CROSS PATTERN DOOR BOLTS

SIZE INS (MM)	FINISH	QTY PER BOX	CODE
12" (300)	Galvanized	5	107 300 1
15" (375)	Galvanized	5	107 375 1
18" (450)	Galvanized	5	107 450 1
24" (600)	Galvanized	5	107 600 1

GARAGE DOOR BOLTS

SIZE INS (MM)	FINISH	QTY PER BOX	CODE
12" x 5/8" (300)	Galvanized	5	520 300 1
12" x 5/8" (300)	Black	5	520 300 3
18" x 5/8" (450)	Galvanized	5	520 450 1
18" x 5/8" (450)	Black	5	520 450 3
24" x 5/8" (600)	Galvanized	5	520 600 1
24" x 5/8" (600)	Black	5	520 600 3
36" x 5/8" (900)	Galvanized	5	520 900 1
36" x 5/8" (900)	Black	5	520 900 3
48" x 5/8" (120)	Galvanized	5	520 120 1
48" x 5/8" (120)	Black	5	520 120 3



HEAVY LOCKING GARAGE DOOR BOLTS

SIZE INS (MM)	FINISH	QTY PER BOX	CODE
18" x 5/8" (450)	Galvanized	10	117 450 1
18" x 5/8" (450)	Black	10	117 450 3
18" x 5/8" (450)	316 SS Brushed Matte	1	117 450 6
18" x 5/8" (450)	316 SS Black	1	117 450 7
24" x 3/4" (600)	Galvanized	1	117 600 1
24" x 3/4" (600)	Black	1	117 600 3

Use with padlock - see page 22. Padlockable.



OVAL PADBOLTS

SIZE INS (MM)	FINISH	QTY PER BOX	CODE
4" (100)	Galvanized	5	514 100 1
4" (100)	Black	5	514 100 3

Use with padlock - see page 22. Padlockable.



TOWER BOLTS

SIZE INS (MM)	FINISH	QTY PER BOX	CODE
4" (100)	Galvanized	5	510 100 1
4" (100)	Zinc	5	510 100 2
4" (100)	Black	5	510 100 3
6" (150)	Galvanized	5	510 150 1
6" (150)	Zinc	5	510 150 2
6" (150)	Black	5	510 150 3



Traditional Hardware



DOOR-GATE HANDLE

SIZE INS (MM)	FINISH	QTY PER BOX	CODE
6" (150)	Galvanized	5	537 150 1
6" (150)	Black	5	537 150 3
8" (200)	Galvanized	5	537 200 1
8" (200)	Black	5	537 200 3



LARGE AUTO GATE CATCHES

SIZE	FINISH	QTY PER BOX	CODE
Large	Galvanized	5	521 002 1
Large	Black	5	521 002 3



DOOR GATE STOPS

SIZE INS (MM)	FINISH	QTY PER BOX	CODE
6" (150)	Epoxy	5	531 150 3

NEW HEAVIER
BACKPLATE



WINDSOR LATCHES

SIZE	FINISH	QTY PER BOX	CODE
Heavy	Galvanized	5	123 003 1
Heavy	Black	5	123 003 3
Heavy	316 SS Brushed Matte	1	523 003 6
Heavy	316 SS Black	1	523 003 7

Suitable for up to 3" thick doors or gates. Self-latching.

Comes with [PADLOCK EYES](#)



NEW HEAVIER
BACKPLATE



SUFFOLK LATCHES

SIZE	FINISH	QTY PER BOX	CODE
Heavy	Galvanized	5	523 002 1
Heavy	Black	5	523 002 3

Suitable for up to 3" thick doors or gates. Self-latching.

Comes with [PADLOCK EYES](#)



LEFT-HANDED OPTION SHOWN

NORTHAM GATE LATCH

SIZE INS (MM)	FINISH	QTY PER BOX	HAND	CODE
7" (175)	Black	10	L/H	130 001 3
7" (175)	Black	10	R/H	130 002 3
7" (175)	Galvanized	10	L/H	130 001 1
7" (175)	Galvanized	10	R/H	130 002 1



SATISFACTION GUARANTEED
We guarantee the performance and quality of every one of our products.

CABIN HOOKS WIRE PATTERN

SIZE INS (MM)	FINISH	QTY PER BOX	CODE
4" (100)	Galvanized	5	532 100 1
4" (100)	Black	5	532 100 3
6" (150)	Galvanized	5	532 150 1
6" (150)	Black	5	532 150 3
8" (200)	Galvanized	5	532 200 1
8" (200)	Black	5	532 200 3
12" (300)	Galvanized	5	532 300 1
12" (300)	Black	5	532 300 3



TWISTED RING GATE LATCHES

SIZE INS (MM)	FINISH	QTY PER BOX	CODE
6" (150)	Galvanized	5	524 150 1
6" (150)	Black	5	524 150 3

Suitable for up to 3" thick doors or gates

For thicker applications, use Extension Spindle, page 18

Comes with **PADLOCK EYES**



TWISTED RING HANDLE ONLY

SIZE INS (MM)	FINISH	QTY PER BOX	CODE
3 1/2" (87)	Galvanized	5	524 150 1 A
3 1/2" (87)	Black	5	524 150 3 A



CRAFTSMAN RING GATE LATCH

NEW

SIZE INS (MM)	FINISH	QTY PER BOX	CODE
6" (150)	Black	5	525 155 3
6" (150)	Brushed Matte	1	525 155 6
6" (150)	316 SS Black	1	525 155 7

Suitable for up to 3" thick doors or gates. Self-latching.

For thicker applications, use Extension Spindle, page 18

Comes with **PADLOCK EYES**



CRAFTSMAN RING HANDLE

NEW

SIZE INS (MM)	FINISH	QTY PER BOX	CODE
3 1/2" (87)	Galvanized	5	525 155 1 A
3 1/2" (87)	Black	5	525 155 3 A



MISCELLANEOUS



HANDRAIL BRACKETS

SIZE INS (MM)	FINISH	QTY PER BOX	CODE
2 1/2" (65)	Zinc	10	180 065 2
2 1/2" (65)	Black	10	180 065 3
3" (75)	Galvanized	10	180 075 1
3" (75)	Zinc	10	180 075 2
3" (75)	Black	10	180 075 3

3" meets new county code standard

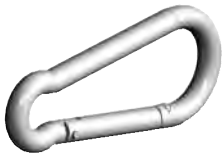

CARBINE HOOKS

SIZE INS (MM)	FINISH	QTY PER PACK	CODE
2" (50)	Zinc	2	587 505 2
2 1/2" (60)	Zinc	2	587 606 2
3" (70)	Zinc	2	587 707 2
3 1/2" (80)	Zinc	2	587 808 2
4" (100)	Zinc	2	249 101 2
4 1/2" (120)	Zinc	2	249 121 2
5 1/2" (140)	Zinc	2	249 141 2

Sizes are approximate

FOR TIGHTENING FENCING CABLE



TURN BUCKLES

SIZE INS (MM)	FINISH	QTY PER BOX	CODE
1/4" (6)	Zinc	10	211 006 2
5/16" (8)	Zinc	10	211 008 2
3/8" (10)	Zinc	10	211 010 2
1/2" (12)	Zinc	10	211 012 2



STAPLES ON PLATES (RECEIVER BRACKET)

SIZE INS (MM)	FINISH	QTY PER PACK	CODE
2" x 2" (50 x 50)	Galvanized	2	583 050 1



HOOKS ON PLATES

SIZE INS (MM)	FINISH	QTY PER PACK	CODE
2" x 2" (50 x 50)	Galvanized	2	582 050 1

FOR USE
IN STABLES



RINGS ON HEAVY DUTY PLATES — EQUESTRIAN

SIZE INS (MM)	FINISH	QTY PER BOX	CODE
4" x 2" (100 x 50)	Galvanized	10	246 150 1
4" x 2" (100 x 50)	Black	10	246 150 3

Other sizes available

QUICK REPAIR LINKS

SIZE INS (MM)	FINISH	QTY PER BOX	CODE
1/4" (6)	Zinc	2	591 006 2
5/16" (8)	Zinc	1	591 008 2
3/8" (10)	Zinc	1	591 010 2

Other sizes available



DEE SHACKLES

SIZE INS (MM)	FINISH	QTY PER BOX	CODE
1/4" (6)	Zinc	4	225 006 2
5/16" (8)	Zinc	2	225 008 2
3/8" (10)	Zinc	2	225 010 2
1/2" (12)	Zinc	2	225 012 2



FLUTED ANGLE BRACKETS

SIZE INS (MM)	FINISH	QTY PER BOX	CODE
3" x 2" (75 X 50)	Galvanized	10	183 075 1
4" x 3" (100 x 75)	Galvanized	10	183 100 1
5" x 4" (125 x 100)	Galvanized	10	183 125 1
6" x 5" (150 X 125)	Galvanized	10	183 150 1
8" x 6" (200 X 150)	Galvanized	10	183 200 1
10" x 8" (250 x 200)	Galvanized	10	183 250 1
12" x 10" (300 x 250)	Galvanized	10	183 300 1



STRONG STAY SHELF BRACKETS

SIZE INS (MM)	FINISH	QTY PER BOX	CODE
16" x 14" (400 X 350)	Grey	10	184 400 8
18" x 16" (450 x 400)	Grey	10	184 450 8



PRE-PACKED HASPS & STAPLES



SAFETY PATTERN HASPS & STAPLES

SIZE	FINISH	QTY PER BOX	CODE
3" (75)	E-Galvanized	5	533 075 2
3" (75)	Black	5	533 075 3
4" (100)	E-Galvanized	5	533 100 2
4" (100)	Black	5	533 100 3
6" (150)	E-Galvanized	5	533 150 2
6" (150)	Black	5	533 150 3



HEAVY HASPS & STAPLES

SIZE	FINISH	QTY PER BOX	CODE
8" (200)	Galvanized	5	535 200 1
8" (200)	Black	5	535 200 3

Galvanized has brass pin



HEAVY SAFETY PATTERN HASP & STAPLE

SIZE	FINISH	QTY PER BOX	CODE
7" (180)	Galvanized	5	538 180 1
7" (180)	Black	5	538 180 3



HEAVY HASP & STAPLES VERTICAL PATTERN

SIZE	FINISH	QTY PER BOX	CODE
6" (150)	Galvanized	5	534 150 1
6" (150)	Black	5	534 150 3



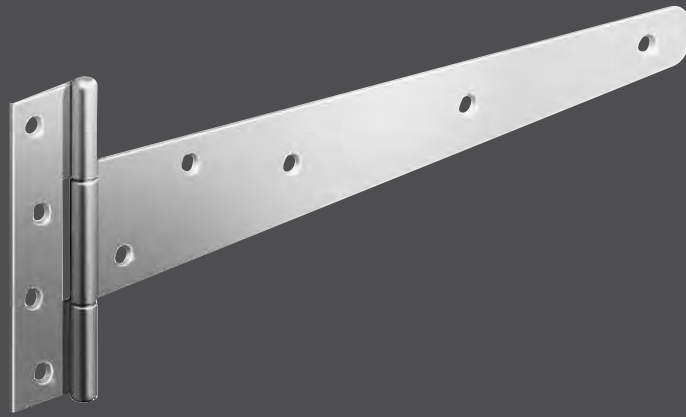

316 Stainless Steel Hardware



Try out our line of 316 marine grade stainless steel gate hardware. It is available in brushed S/S or black and comes with stainless steel fasteners. Ideal for coastal areas. Long lasting for any application.



GATEMATE[®]



CRANKED BANDS AND HOOKS

SIZE INS	FINISH	QTY PER BOX	CODE
18"	316 SS BRUSHED MATTE	1 PAIR	507 4506
18"	316 SS BLACK	1 PAIR	507 4507
24"	316 SS BRUSHED MATTE	1 PAIR	507 6006
24"	316 SS BLACK	1 PAIR	507 6007



STRONG TEE HINGE

SIZE INS	FINISH	QTY PER BOX	CODE
8"	316 SS BRUSHED MATTE	1 PAIR	505 2006
8"	316 SS BLACK	1 PAIR	505 2007
12"	316 SS BRUSHED MATTE	1 PAIR	505 3006
12"	316 SS BLACK	1 PAIR	505 3007



ADJUSTABLE BANDS AND HOOKS

SIZE INS	FINISH	QTY PER BOX	CODE
18"	316 SS BRUSHED MATTE	1 PAIR	508 4506
18"	316 SS BLACK	1 PAIR	508 4507
24"	316 SS BRUSHED MATTE	1 PAIR	508 6006
24"	316 SS BLACK	1 PAIR	508 6007



RING GATE LATCH

SIZE INS	FINISH	QTY PER BOX	CODE
6"	316 SS BRUSHED MATTE	1	525 1506
6"	316 SS BLACK	1	525 1507

Suitable for up to 3" thick doors or gates.

For thicker applications, use Extension Spindle, page 18.



BRENTON PADBOLTS 1/2" SHOOT

SIZE INS	FINISH	QTY PER BOX	CODE
6 x 1/2"	316 SS BRUSHED MATTE	1	512 1506
6 x 1/2"	316 SS BLACK	1	512 1507

Padlockable



BRENTON PADBOLTS 5/8" SHOOT

SIZE INS	FINISH	QTY PER BOX	CODE
8 x 5/8"	316 SS BRUSHED MATTE	1	513 2006
8 x 5/8"	316 SS BLACK	1	513 2007

Padlockable



SATISFACTION GUARANTEED

We guarantee the performance and quality of every one of our products.

CRAFTSMAN RING GATE LATCH

NEW

SIZE INS (MM)	FINISH	QTY PER BOX	CODE
6" (150)	316 SS BRUSHED MATTE	1	525 1556
6" (150)	316 SS BLACK	1	525 1557

Comes with PADLOCK EYES. Self-latching.
 Suitable for up to 3" thick doors or gates.
 For thicker applications, use Extension Spindle, page 18.

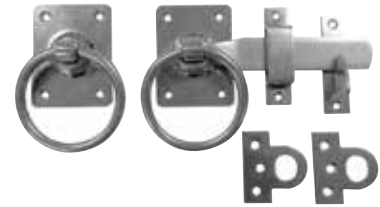

CRAFTSMAN RING HANDLE

NEW

SIZE INS (MM)	FINISH	QTY PER BOX	CODE
3 1/2" (87)	316 SS BRUSHED MATTE	1	525 1556A
3 1/2" (87)	316 SS BLACK	1	525 1557A



HEAVY WINDSOR LATCH

SIZE	FINISH	QTY PER BOX	CODE
HEAVY	316 SS BRUSHED MATTE	1	523 0036
HEAVY	316 SS BLACK	1	523 0037

Suitable for up to 3" thick doors or gates. Self-latching.

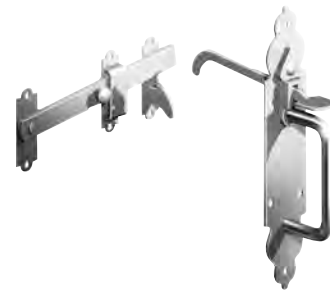

NEW HEAVIER
BACK PLATE

HEAVY LOCKING GARAGE DOOR BOLTS

SIZE INS	FINISH	QTY PER BOX	CODE
18 x 5/8"	316 SS BRUSHED MATTE	1	117 4506
18 x 5/8"	316 SS BLACK	1	117 4507

Padlockable



CABIN HOOK

SIZE INS	FINISH	QTY PER BOX	CODE
4"	316 SS BRUSHED MATTE	1	541 1006





NEW Heavy Reversible Hinge
WITH NYLON BUSHINGS

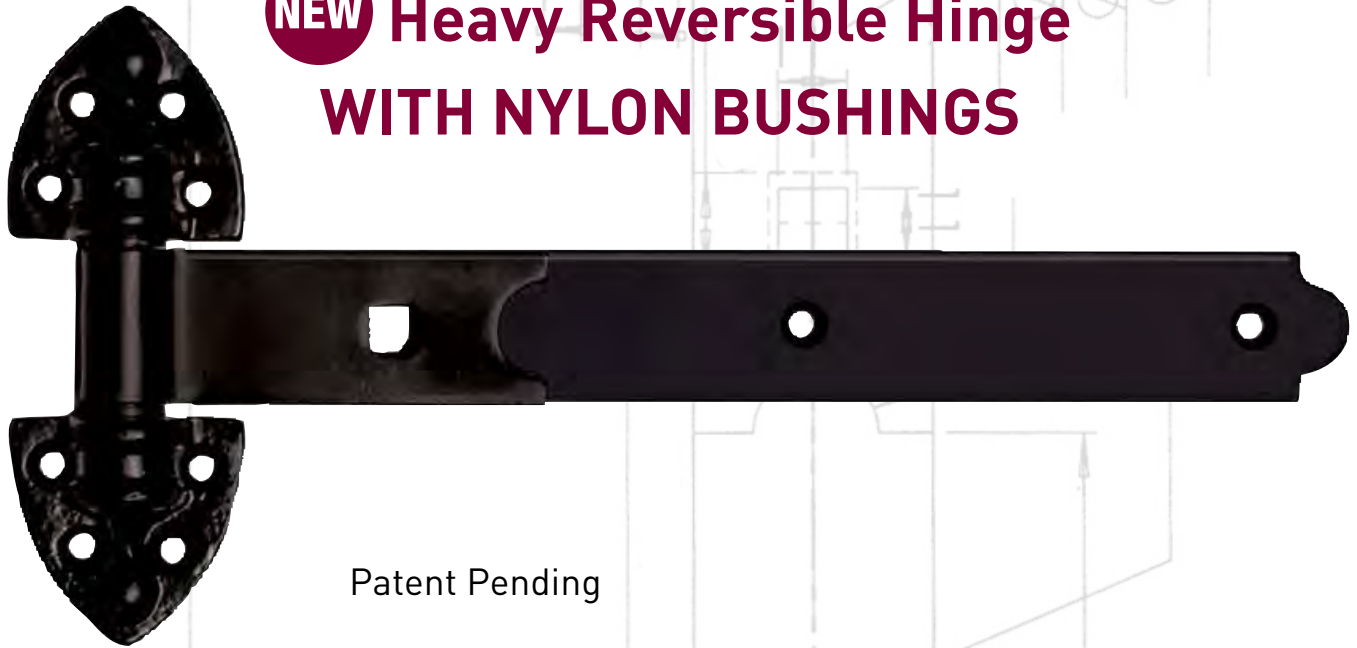

Patent Pending

12" 509 3003 – NYL

18" 509 4503 – NYL

Nylon Bushings For Easy Movement
between Cup and Band – prevents chipping

Stainless Steel Screws included

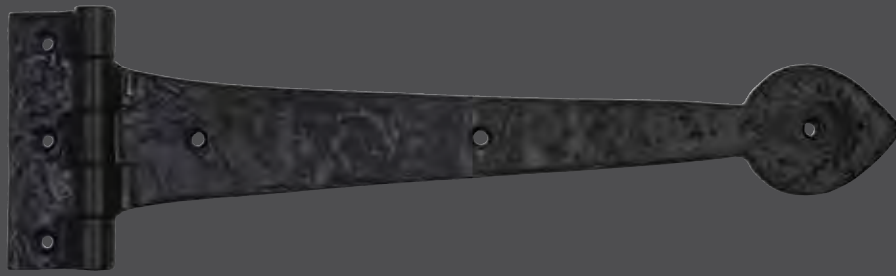

Antique Ironmongery

This section features an extensive range of *Hand Crafted* old world style wood gate & door hardware. Other uses include shutters, garage doors, furniture, and cabinet applications. All Antique Ironmongery finished with a quality, heavy black powder coat over zinc plate. Comes with stainless steel screws.



GATEMATE[®]

Antique Ironmongery

PRE-PACKED ANTIQUE IRONMONGERY WITH 304 BLACK STAINLESS STEEL SCREWS



ANTIQUE TEE HINGES

SIZE INS (MM)	FINISH	PAIRS PER BOX	CODE
6" (150)	Dull Black	5	550 150 3
9" (225)	Dull Black	5	550 225 3
12" (300)	Dull Black	5	550 300 3



ANTIQUE COLONIAL HINGES

SIZE INS (MM)	FINISH	PAIRS PER BOX	CODE
12" (300)	Dull Black	5	574 300 3
18" (450) Heavy Duty	Dull Black	5	574 450 3
24" (600) Heavy Duty	Dull Black	5	574 600 3



ANTIQUE FLEUR DE LEYS HINGES

SIZE INS (MM)	FINISH	PAIRS PER BOX	CODE
12" (300)	Dull Black	5	551 300 3



ANTIQUE HEAVY DUTY FLEUR DE LEYS HINGES

SIZE INS (MM)	FINISH	PAIRS PER BOX	CODE
16" (400)	Dull Black	5	551 400 3



ANTIQUE BUTTERFLY HINGES

SIZE INS (MM)	FINISH	PAIRS PER BOX	CODE
2 3/4" x 2" (70 x 50)	Dull Black	5	552 705 3



ANTIQUE UNEQUAL HINGE

SIZE INS (MM)	FINISH	PAIRS PER BOX	CODE
4" x 3" (100x75)	Dull Black	5	553 100 3



ANTIQUE HINGE FRONTS ONLY F.D.L.

SIZE INS (MM)	FINISH	PAIRS PER BOX	CODE
11" (275)	Dull Black	5	554 275 3



ANTIQUE HINGE FRONTS ONLY F.D.L.

SIZE INS (MM)	FINISH	PAIRS PER BOX	CODE
12" (300)	Dull Black	5	554 300 3
16" (400)	Dull Black	5	554 400 3

PRE-PACKED ANTIQUE IRONMONGERY WITH 304 BLACK STAINLESS STEEL SCREWS

ANTIQUE COLONIAL HINGE FRONTS ONLY

SIZE INS (MM)	FINISH	PAIRS PER BOX	CODE
9" (225)	Dull Black	5	554 225 3
12" (300)	Dull Black	5	554 303 3
18" (450)	Dull Black	5	554 450 3
24" (600)	Dull Black	5	554 600 3



ANTIQUE HOOK & BAND HINGES

SIZE INS (MM)	FINISH	PAIRS PER BOX	CODE
12" (300)	Dull Black	6	563 300 3
18" (450)	Dull Black	6	563 450 3
24" (600)	Dull Black	6	563 600 3



ANTIQUE LEVER LOCK HANDLE

SIZE INS (MM)	FINISH	PAIRS PER BOX	CODE
6" x 2" (150x50)	Dull Black	5	555 150 3

Suitable for up to 3" thick doors or gates. Recommended for use with Mortise Sash Lock below. For thicker applications, use Extension Spindle, page 18.
Can be used on French doors.



ANTIQUE LEVER LOCK HANDLE F.D.L.

SIZE INS (MM)	FINISH	PAIRS PER BOX	CODE
7" x 2" (175x50)	Dull Black	5	556 175 3

Suitable for up to 3" thick doors or gates. Recommended for use with Mortise Sash Lock below. For thicker applications, use Extension Spindle, page 18



MORTISE SASH LOCK

SIZE INS (MM)	FINISH	QTY PER BOX	CODE
2 3/4" (65)	Satin	5	149 002 0

Reversible for LH or RH doors. Recommended for use with Lever Lock Handles above. See other lock sets on page 22.



ANTIQUE STRAIGHT DOOR BOLTS

SIZE INS (MM)	FINISH	QTY PER BOX	CODE
6" (150)	Dull Black	5	557 150 3
8" (200)	Dull Black	5	557 200 3



ANTIQUE CASEMENT STAYS

SIZE INS (MM)	FINISH	QTY PER BOX	CODE
10" (250)	Dull Black	5	558 250 3



ANTIQUE CABIN HOOKS

SIZE INS (MM)	FINISH	QTY PER BOX	CODE
4" (100)	Dull Black	5	559 100 3
6" (150)	Dull Black	5	559 150 3



Antique Ironmongery

PRE-PACKED ANTIQUE IRONMONGERY WITH 304 BLACK STAINLESS STEEL SCREWS



ANTIQUE DOOR HANDLE F.D.L.

SIZE INS (MM)	FINISH	QTY PER BOX	CODE
4" (100)	Dull Black	5	560 100 3
6" (150)	Dull Black	5	560 150 3
10" (250)	Dull Black	5	560 250 3



ANTIQUE RING GATE LATCH

SIZE INS (MM)	FINISH	QTY PER BOX	CODE
8" (200)	Dull Black	5	561 200 3

Suitable for up to 4" thick doors or gates

For thicker applications, use Extension Spindle, see below

Comes with **PADLOCK EYES**



ANTIQUE RING HANDLE ONLY

SIZE INS (MM)	FINISH	QTY PER BOX	CODE
4" (100)	Dull Black	5	561 200 3 A



EXTENSION SPINDLE

SIZE INS (MM)	FINISH	QTY PER BOX	CODE
5 3/8" (130)	Zinc	5	561 130 2



ANTIQUE SUFFOLK LATCH

SIZE INS (MM)	FINISH	QTY PER BOX	CODE
6" (150)	Dull Black	5	564 150 3

Suitable for up to 2 1/4" thick doors or gates

Can be used with padlock eyes, page 22.

ANTIQUE HEAVY SUFFOLK LATCH

SIZE INS (MM)	FINISH	QTY PER BOX	CODE
10" (250)	Dull Black	5	564 250 3

Suitable for up to 4" thick doors or gates

Can be used with padlock eyes, page 22.



ANTIQUE SUFFOLK HANDLE ONLY

SIZE INS (MM)	FINISH	QTY PER BOX	CODE
6" (150)	Black		564 150 3A
10" (150)	Black		564 250 3A

BRASS



NEW

ANTIQUE NAUTICAL DINNER BELL

SIZE INS (MM)	FINISH	QTY PER BOX	CODE
5" (125)	Black	1	577 125 3

PRE-PACKED ANTIQUE IRONMONGERY WITH 304 BLACK STAINLESS STEEL SCREWS

ANTIQUE GEORGIAN DOOR KNOCKER

SIZE INS (MM)	FINISH	QTY PER BOX	CODE
8"	Dull Black	5	569 200 3



ANTIQUE LION DOOR KNOCKER

SIZE INS (MM)	FINISH	QTY PER BOX	CODE
4" (100)	Dull Black	5	569 000 3



ANTIQUE HEAVY DOOR PULL

SIZE INS (MM)	FINISH	QTY PER BOX	CODE
10" (250)	Dull Black	5	568 250 3



ANTIQUE MISION DOOR PULL

SIZE INS (MM)	FINISH	QTY PER BOX	CODE
14" (350)	Black	5	568 350 3



ANTIQUE MISSION DOOR GRILL

SIZE INS (MM)	FINISH	QTY PER BOX	CODE
12" (300)	Dull Black	1	575 303 3



ANTIQUE SPEAK EASY GRILL

SIZE INS (MM)	FINISH	QTY PER BOX	CODE
6 3/4" (170)	Dull Black	1	575 170 3
12" (300)	Dull Black	1	575 300 3



ANTIQUE 0-9 NUMERICALS

SIZE INS (MM)	FINISH	QTY PER BOX	CODE
3" (75)	Dull Black	5	570 003 0-9
5" (125)	Dull Black	5	570 123 0-9
7" (175)	Dull Black	5	570 175 0-9



3" 0123456789
 5" 0123456789
 7" 0123456789

7" MEETS NEW SIZE REQUIREMENTS FOR EMERGENCY RESPONSE

Antique Ironmongery

PRE-PACKED ANTIQUE IRONMONGERY WITH 304 BLACK STAINLESS STEEL SCREWS



ANTIQUE DROP ROD

SIZE INS (MM)	FINISH	QTY PER BOX	CODE
24 x 5/8"	Dull Black	5	518 600 3



ANTIQUE CAST BALL KNOB FURNITURE

SIZE INS (MM)	FINISH	QTY PER BOX	CODE
1 3/4" (45)	Dull Black	5	575 045 3

See lock hardware page 22.

Works with lock #1490020

Extension Spindle allows up to 3 1/4" thick door gate.



ANTIQUE BELL PUSH

SIZE INS (MM)	FINISH	QTY PER BOX	CODE
5" (125)	Dull Black	5	571 000 3



WILLIAMSBURG GRAVITY GATE CLOSER

SIZE INS (MM)	FINISH	QTY PER BOX	CODE
3 3/4" (95)	Dull Black	5	577 095 3



ANTIQUE DOOR STUDS

SIZE INS (MM)	FINISH	QTY PER PACK	PACKAGED CODE	BULK CODE
3/4" (19)	Dull Black	10	562 019 3	162 019 3
1 1/8" (32)	Dull Black	10	562 032 3	162 032 3
1 1/2" (37)	Dull Black	5	562 037 3	162 037 3



ANTIQUE CLAVOS

SIZE INS (MM)	FINISH	QTY PER PACK	PACKAGED CODE	BULK CODE
1 1/8" (25)	Black	10	562 025 9	162 025 9
1 1/2" (37)	Black	5	562 037 9	162 037 9



NEW

ANTIQUE COAT HOOK

SIZE INS (MM)	FINISH	QTY PER BOX	CODE
6" (150)	Black	5	548 150 3



NEW

GATEMATE GATE SIGNS

DESCRIPTION	SIZE MM	FINISH	QTY PER BOX	CODE
Please shut the gate	160 x 55mm	Brass	5	544 000 5
Please shut the gate	160 x 55mm	Chrome	5	544 000 C
Beware of the dog	160 x 55mm	Brass	5	544 001 5
Beware of the dog	160 x 55mm	Chrome	5	544 001 C



Security Products

Unique locking hardware for a variety of security applications including custom gates and doors.



GATEMATE[®]



BRASS PADLOCKS

SIZE INS (MM)	FINISH	QTY PER BOX	CODE
1 1/4" (30)	Chrome Shackle	6	539 030 0
1 1/2" (40)	Chrome Shackle	6	539 038 0
2" (50)	Chrome Shackle	6	539 050 0
2 1/2" (65)	Chrome Shackle	6	539 005 0

Includes 3 keys

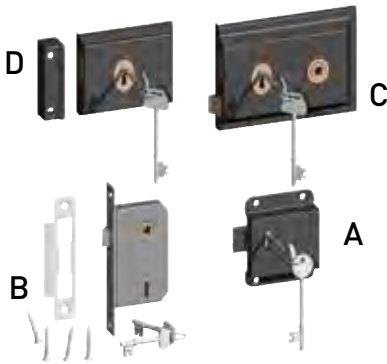

GATE & DOOR LOCKS

TYPE	SIZE INS	FINISH	CODE
Presslock (A)	3"	Epoxy Black	149 001 3
Mort Sash Lock - 3 lever (B)	2 1/2"	Satin	149 002 0
Mort Sash Lock - 3 lever (B)	2 1/2"	Satin	149 002 0 HD HEAVY DUTY
Rimsashlock - 2 lever (C)	6 x 4"	Black	149 003 0
Rimdeadlock - 2 lever (D)	4 x 3"	Grey	149 004 0

See page 17 for door handles.

(B) works with 5551503 and 5561753 on page 17.



PADLOCK PROTECTOR

SIZE INS (MM)	FINISH	QTY PER BOX	CODE
7 1/2" x 2 1/2" (185 x 60)	Black	5	538 185 3



AQUALATCH - POOL SAFETY LATCH

SIZE INS	FINISH	QTY PER BOX	CODE
Post: 2" to 5"	Glass-filled Nylon/Aluminum	20	AQUA 20 BK

For more polymer products see pages 51-53.



NEW

PADLOCK EYES

SIZE INS	FINISH	PRS PER BOX	CODE
2 1/8"	Black	1/5	149 051 0



NEW

SPADE DRILL FOR LONG THROW LOCKS

SIZE INS (MM)	QTY PER BOX	CODE
1 1/8" (28)	1	SPO 028 0



SATISFACTION GUARANTEED

We guarantee the performance and quality of every one of our products.

LONG THROW LOCKS

TYPE	THROW LENGTH	KEY CYL. LENGTH	FINISH	QTY PER BOX	CODE
Double Cylinder (B)	2 1/2" (60)	2" (50)	Stainless/Black	1/20	149 018 6
Double Cylinder (B)	2 1/2" (60)	2 3/4" (70)	Stainless/Black	1/20	149 019 6
Single Cylinder (A)	2 1/2" (60)	2" (50)	Stainless/Black	1/20	149 110 6
Single Cylinder (A)	2 1/2" (60)	2 3/4" (70)	Stainless/Black	1/20	149 111 6



SLIDE ACTION / SINGLE-SIDED WITH BUTTON ON ONE SIDE

LONG THROW LOCKS - KEYED ALIKE

TYPE	THROW LENGTH	KEY CYL. LENGTH	FINISH	QTY PER BOX	CODE
Double Cylinder (B)	2 1/2" (60)	2" (50)	Stainless/Black	1/20	149 112 6
Double Cylinder (B)	2 1/2" (60)	2 3/4" (70)	Stainless/Black	1/20	149 113 6
Single Cylinder (A)	2 1/2" (60)	2" (50)	Stainless/Black	1/20	149 114 6
Single Cylinder (A)	2 1/2" (60)	2 3/4" (70)	Stainless/Black	1/20	149 115 6



DOUBLE-SIDED / KEYED ON BOTH SIDES

Ideal Security for Gates / Easy to install.
Comes with 5 keys. #149000 - spare keys.

RIM LOCK HANDLE

NEW

SIZE INS (MM)	FINISH	QTY PER BOX	CODE
8" (200)	Black	1/20	147 200 3 RLH



[See more Security Products on page 51-53](#)

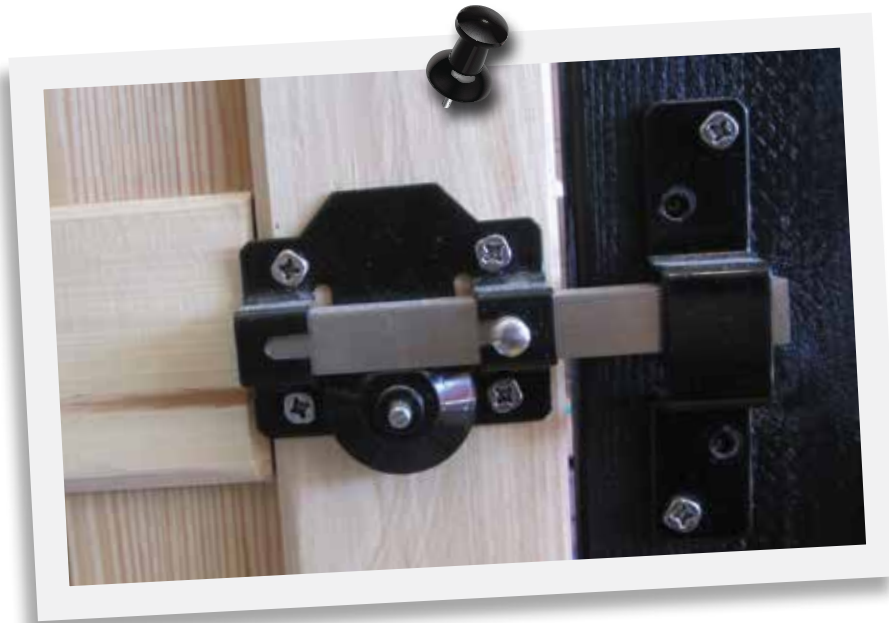



**Ask
about our
program to
receive these
displays
*FREE!***

NEW

RETAIL COUNTER DISPLAYS

**RIM LOCK
COUNTER DISPLAY**



- FEATURES & BENEFITS OF RIM LOCK:
- BEST LOCK FOR WOOD GATES ON THE MARKET
 - LONG THROW -RESOLVES PROBLEM OF EXPANSION & CONTRACTION ISSUES
 - VERY EASY TO INSTALL-NO MORTISING
 - DESIGNED IN EUROPE
 - VERY GOOD VALUE
 - 316 STAINLESS STEEL - WEATHER RESISTANT (RUST PROOF)
 - AVAILABLE IN 2" & 2 3/4", SINGLE & DOUBLE CYLINDER
 - OPTIONAL KEYED ALIKE FOR PROJECTS WITH MULTIPLE GATES

**CRAFTSMAN LATCH
COUNTER DISPLAY**



CRAFTSMAN LATCH, EXCLUSIVELY GATEMATE

SEE OUR FULL LINE OF 316 SS MARINE
GRADE HARDWARE ON PAGE 11



Gate Frames & Iron Gates

Premade iron gates and gate frames.
Both adjustable for quick and easy installation.



**Ask
about our
Gate Frame
Display
Program**

GATEMATE®

RETAIL WORKING GATE FRAME DISPLAY AVAILABLE, SEE PAGE 69

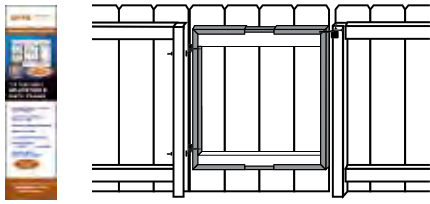

ADJUSTABLE GATE FRAME

SIZE INS	FINISH	QTY PER BOX/PALLET	CODE
24" - 51" Expanding	Black	1/60	701 000 3

All hardware included. Includes Hanger bolts and latch.
Quick and strong assembly.

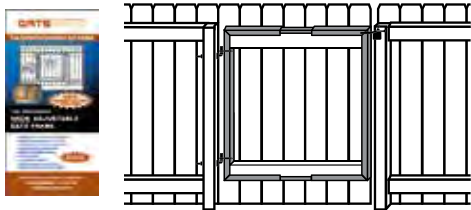

ADJUSTABLE WIDE GATE FRAME

SIZE INS	FINISH	QTY PER BOX/PALLET	CODE
48" - 84" Expanding	Black	1/12	702 000 3

All hardware included. Includes Hanger bolts, latch and drop rod.
Quick and strong assembly.

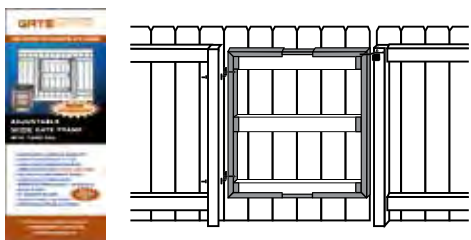

ADJUSTABLE WIDE GATE FRAME WITH THIRD RAIL

SIZE INS	FINISH	QTY PER BOX/PALLET	CODE
60" - 96" Expanding	Black	1/12	704 000 3

All hardware included

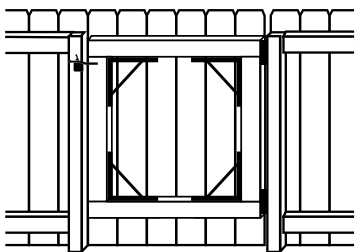

READY GATE (ANTI-SAG KIT)

SIZE INS	FINISH	QTY PER BOX	CODE
For 25" - 72" Gate Openings	Black	1/10	705 000 3



All hardware included



BUILDING ATTACHMENT KIT

SIZE INS	FINISH	PAIRS PER BOX	CODE
Fits 701 and 702 series	Black	1	703 000 3



SATISFACTION GUARANTEED
We guarantee the performance and quality of every one of our products.

ASCOT IRON GATE

SIZE INS	FINISH	QTY PER BOX	CODE
38" x 33"	Black	1	802 100 3

Comes with adjustable hinge set and latch. Pad lockable.



WINDSOR IRON GATE

SIZE INS	FINISH	QTY PER BOX	CODE
76" x 33"	Black	1	803 100 3

Comes with adjustable hinge set and latch. Pad lockable.



METAL GATE POST

SIZE MM	FINISH	QTY PER BOX	CODE
1300 x 50 x 50	Polyester Black on BZP	1	800 130 0
2400 x 50 x 50	Polyester Black on BZP	1	800 240 0

Post supplied with plastic end caps and self drilling screws for gate fixing kits.

NEW





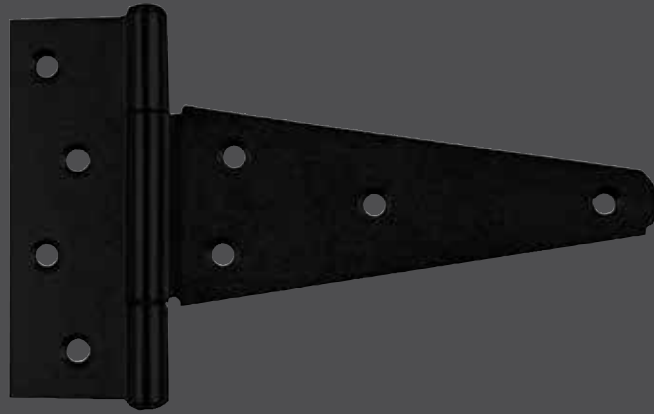

Standard Gate Components

This section includes a full range of quality, everyday, wood gate hardware. Most standard products are available in zinc plated, hot dipped galvanized, and powder coated black finishes.



GATEMATE

Standard Gate Components

STANDARD COMPONENTS



PRE-PACKED

STANDARD TEE HINGES

SIZE INS (MM)	FINISH	QTY PER BOX	CODE	PRE-PACKED CODE
3" (75)	Galvanized	10/100	004 075 1	
3" (75)	Zinc	10/100	004 075 2	
3" (75)	Black	10/100	004 075 3	
4" (100)	Galvanized	10/100	004 100 1	
4" (100)	Zinc	10/100	004 100 2	
4" (100)	Black	10/100	004 100 3	
6" (150)	Galvanized	10/60	004 150 1	
6" (150)	Zinc	10/60 (5/30 PP)	004 150 2	050 150 2
6" (150)	Black	10/60 (5/30 PP)	004 150 3	050 150 3
8" (200)	Galvanized	10/30	004 200 1	
8" (200)	Zinc	10/30	004 200 2	
8" (200)	Black	10/30	004 200 3	
10" (250)	Galvanized	10/30	004 250 1	
10" (250)	Zinc	10/30	004 250 2	
10" (250)	Black	10/30	004 250 3	

Galvanized hinges have brass pins . Pre-packed hinges come with screws.

HD STANDARD TEE HINGES *HEAVY DUTY*

SIZE INS (MM)	FINISH	QTY PER BOX	CODE	PRE-PACKED CODE
NEW FINISH 6" (150)	Zinc	10/40	004 155 2	
6" (150)	Black	10/40 (10/20 PP)	004 155 3	050 155 3



SQUARE TEE HINGE

SIZE INS (MM)	FINISH	QTY PER BOX	CODE	PRE-PACKED CODE
6" (150)	Zinc	10/60 (5/30 PP)	602 150 2	052 150 2
6" (150)	Black	10/60 (5/30 PP)	602 150 3	052 150 3

Pre-packed hinges come with #10 x 1 1/2" screws.



OFFSET HINGES

SIZE INS (MM)	FINISH	QTY PER BOX	CODE	PRE-PACKED CODE
3 1/2" (89)	Galvanized	10/60	602 001 1	
3 1/2" (89)	Zinc	10/60	602 001 2	
3 1/2" (89)	Black	10/60 (5/30 PP)	602 001 3	052 001 3

Galv. hinges have brass pins. Pre-packed hinges come with black 1/4 x 2" hex screws.

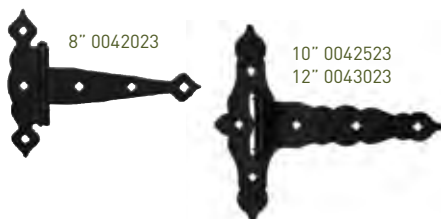

8" 0042023

10" 0042523
12" 0043023

ESTATE TEE HINGES

SIZE INS (MM)	FINISH	PAIRS PER BOX	CODE
8" (200)	Black	5/20	004 202 3
10" (250)	Black	5/15	004 252 3
12" (300)	Black	5/10	004 302 3

Packed in polythene sleeves - including screws. 10" and 12" have 3" carriage bolts for gate and 3" hex screws for post. 8" has 2" hex screws.

ESTATE SELF-CLOSING TEE HINGE

SIZE INS (MM)	FINISH	PAIR PER BOX	CODE
8" (200)	Black	10/20	004 222 3

Fasteners included, self-closing, spring loaded



FANCY TEE HINGES (REMOVABLE PIN)

SIZE INS (MM)	FINISH	QTY PER BOX	PRE-PACKED CODE
8" (200)	Black	10/40	050 205 3
10" (250)	Black	10/30	050 255 3



FANCY BUTTERFLY HINGE

SIZE INS (MM)	FINISH	PAIR PER BOX	CODE
8" (200)	Black	10/20	005 055 3

Fasteners included, heavy duty



FANCY STRAP HINGE

SIZE INS (MM)	FINISH	PAIR PER BOX	CODE
8" (200)	Black	10/20	005 205 3
10" (250)	Black	10/20	005 255 3

Fasteners included, heavy duty



BUTT HINGE (REMOVABLE PIN)

SIZE INS (MM)	FINISH	QTY PER BOX	CODE
4" (100)	Galvanized	10/100	019 100 1
4" (100)	Zinc	10/100	019 100 2
4" (100)	Black	10/100	019 100 3

Packed in polythene sleeves - including screws.



HEAVY STRAP HINGES

SIZE INS (MM)	FINISH	QTY PER BOX	CODE
4" (100)	Galvanized	10/50	005 100 1
4" (100)	Zinc	10/50	005 100 2
4" (100)	Black	10/50	005 100 3
6" (150)	Galvanized	10/40	005 150 1
6" (150)	Zinc	10/40	005 150 2
6" (150)	Black	10/40	005 150 3
8" (200)	Galvanized	10/30	005 201 1
8" (200)	Zinc	10/30	005 201 2
8" (200)	Black	10/30	005 201 3

Galvanized hinges have brass pins

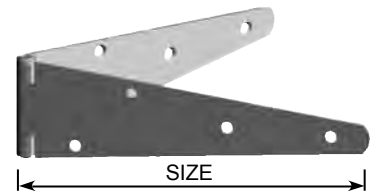

SLIDE BOLTS

SIZE INS (MM)	FINISH	QTY PER BOX	CODE
6" (150)	Galvanized	10/80	602 002 1
6" (150)	Zinc	10/80	602 002 2
6" (150)	Black	10/80	602 002 3

Packed in polythene sleeves - including screws



Standard Gate Components



CANE BOLTS

SIZE INS (MM)	FINISH	QTY PER BOX	CODE
12" x 1/2" (300)	Galvanized	10/30	602 004 1
12" x 1/2" (300)	Zinc	10/30	602 004 2
12" x 1/2" (300)	Super Black	10/30	602 004 3
18" x 1/2" (450)	Galvanized	10/30	602 003 1
18" x 1/2" (450)	Zinc	10/30	602 003 2
18" x 1/2" (450)	Super Black	10/30	602 003 3
24" x 5/8" (600)	Zinc	10/20	602 015 2
24" x 5/8" (600)	Super Black	10/20	602 015 3
36" x 5/8" (900)	Black	1/10	602 900 3
48" x 5/8" (1200)	Black	1/10	602 120 3

Packed in polythene sleeves - including screws

BIG MOUTH



AUTO LATCH

SIZE INS (MM)	FINISH	QTY PER BOX	CODE
2" (50)	Galvanized	10/100	601 001 1
2" (50)	Zinc	10/100	601 001 2
2" (50)	Super Black	10/100	601 001 3

Packed in polythene sleeves - including screws



AUTO LATCH WITH 90° STRIKE

SIZE INS (MM)	FINISH	QTY PER BOX	CODE
2" (50)	Zinc	10/100	601 000 2
2" (50)	Super Black	10/100	601 000 3

Packed in polythene sleeves - including screws



AUTO LATCH WITH CABLE

SIZE INS (MM)	FINISH	QTY PER BOX	CODE
2" (50)	Galvanized	10/100	601 101 1
2" (50)	Zinc	10/100	601 101 2
2" (50)	Black	10/100	601 101 3

Packed in polythene sleeves - including screws



ALSO AVAILABLE WITHOUT CABLE

HD AUTO LATCH WITH CABLE

SIZE INS (MM)	FINISH	QTY PER BOX	CODE
3" (75)	Galvanized	5/30	602 110 1
3" (75)	Zinc	5/30	602 110 2
3" (75)	Super Black	5/30	602 110 3

Packed in polythene sleeves - including screws

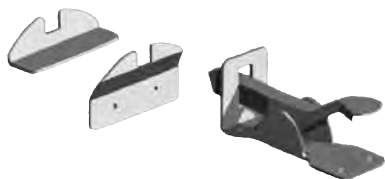

TOP MOUNT GATE LATCH

SIZE INS (MM)	FINISH	QTY PER BOX	CODE
4 1/2" (105)	Galvanized	10/50	602 011 1
4 1/2" (105)	Zinc	10/50	602 011 2
4 1/2" (105)	Super Black	10/50	602 011 3

Packed in polythene sleeves - including screws

POST MOUNT GATE LATCH

SIZE INS (MM)	FINISH	QTY PER BOX	ASSEMBLED CODE	QTY PER BOX	UNASSEMBLED CODE
10 1/2" (265)	Super Black	10/30	602 007 3	50/CASE	602 027 3

Packed in polythene sleeves - including screws. 2-sided entry.



OPTIMA POST LATCH

SIZE INS (MM)	FINISH	QTY PER BOX	CODE
9" (225)	Black	10/20	602 017 3

Fasteners included, pad lockable, locking feature



FLOATING BAR LATCH

SIZE INS (MM)	FINISH	QTY PER BOX	CODE
2" (50)	Zinc	10/50	601 003 2
2" (50)	Black	10/50	601 003 3

Fasteners included, pad lockable



HD FLOATING BAR LATCH

SIZE INS (MM)	FINISH	QTY PER BOX	CODE
3" (75)	Black	5/25	601 004 3

Fasteners included, pad lockable



ROUND RAIL LOOP LATCH

SIZE INS (MM)	FINISH	QTY PER BOX	CODE
10" (250)	Zinc	10/60	189 100 2

Post and rail fencing, heavy duty. Fasteners included.



SPLIT RAIL LOOP LATCH

SIZE INS (MM)	FINISH	QTY PER BOX	CODE
8" (200)	Zinc	10/60	188 200 2

Fasteners included



NEW

LOCKABLE THUMB LATCH

SIZE INS (MM)	FINISH	QTY PER BOX	CODE
10 1/2" (255)	Super Black	5/30	602 008 3

Packed in polythene sleeves - including screws



LOOPED RING GATE LATCH

SIZE INS (MM)	FINISH	QTY PER BOX	CODE
2" (50)	Zinc	10/100	602 005 2

Packed in polythene sleeves - including screws



FENCE CLIP

SIZE INS (MM)	FINISH	QTY PER BOX	CODE
2" (50)	Zinc	150	FB24G



Standard Gate Components



PULL HANDLE

SIZE INS (MM)	FINISH	QTY PER BOX	CODE
8" (200)	Galvanized	10/100	147 175 1
8" (200)	Zinc	10/100	147 175 2
8" (200)	Super Black	10/100	147 175 3

Packed in polythene sleeves - including screws



GATE HANDLE

SIZE INS (MM)	FINISH	QTY PER BOX	CODE
8" (200)	Black	10/100	147 200 3

Fasteners included



ROUNDED GATE HANDLE

SIZE INS (MM)	FINISH	QTY PER BOX	CODE
6" (150)	Black	10/100	147 150 3

Stainless Steel Fasteners included



THUMB HANDLE

SIZE INS (MM)	FINISH	QTY PER BOX	CODE
10 1/2" (255)	Super Black	10/100	602 008 3-A



GATE RETURN SPRING

SPRING LENGTH	FINISH	QTY PER BOX	CODE
8" (200)	Zinc	10/40	526 200 2
8" (200)	Super Black	10/40	526 200 3
10" (250)	Zinc	10/40	526 250 2
10" (250)	Super Black	10/40	526 250 3

Packed in polythene sleeves - including screws

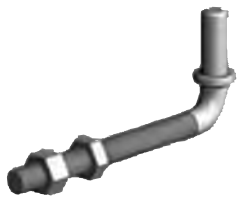

J BOLT HANGER

SIZE INS (MM)	FINISH	QTY PER BOX	CODE
6" x 5/8" (150)	Zinc	10/50	601 658 2
10" x 5/8" (250)	Zinc	10/50	601 108 2
10" x 5/8" (250)	Galvanized	10/50	601 108 1



ADJUSTABLE EYE BOLT

SIZE INS (MM)	FINISH	QTY PER BOX	CODE
6" x 5/8" (150)	Zinc	10/50	049 616 2

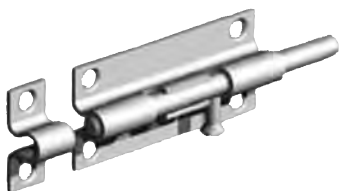

BARREL BOLTS

SIZE INS (MM)	FINISH	QTY PER BOX	CODE
4" (100)	Galvanized	10/100	602 100 1
4" (100)	Zinc	10/100	602 100 2
4" (100)	Super Black	10/100	602 100 3

Packed in polythene sleeves - including screws

HASP & STAPLE SWIVEL HEAD

SIZE INS (MM)	FINISH	QTY PER BOX	CODE
4 1/2" (115)	Zinc	10/100	602 006 2

Packed in polythene sleeves - including screws



HEAVY DUTY SPRING LOADED GATE WHEEL

SIZE INS (MM)	FINISH	QTY PER BOX	CODE
14 1/2" (370)	Galvanized	1/5	081 368 1
14 1/2" (370)	Zinc	1/5	081 368 2
14 1/2" (370)	Black	1/5	081 368 3

Packed in polythene sleeves - carriage bolts included

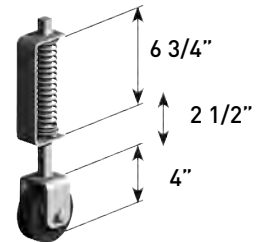

MEDIUM SPRING LOADED GATE WHEEL

SIZE INS (MM)	FINISH	QTY PER BOX	CODE
11" (280)	Zinc	1/5	081 280 2

Swivels



ANTI-SAG KIT

SIZE INS (MM)	FINISH	QTY PER BOX	CODE
120"	Zinc	10/100	188 100 2

Fasteners included



GATE HARDWARE KIT

NEW

FINISH	QTY PER BOX	CODE
Black	1 SET/20 SETS	098 150 3

INCLUDES:

Auto Latch with Cable (6011013)

8" Pull Handle (1471753),

Pair of 6" Tee Hinges (0501503)

All fasteners included. Boxed with label.



GAS GATE CLOSER

NEW

DESCRIPTION	SIZE INS (MM)	FINISH	QTY PER BOX	CODE
Surface fixed bracket	30" (750)	Black	1	134 750 3
Weld on bracket	30" (750)	Black	1	134 751 3

Maximum weight 176 lbs



SMALL HYDRAULIC GATE CLOSER

NEW

SIZE INS (MM)	FINISH	QTY PER BOX	CODE
12" (300)	Black	1	134 300 3

Maximum weight 110 lbs



Standard Gate Components



NEW

SCREW HOOK AND EYE HINGE

SIZE INS	FINISH	QTY PER BOX	CODE
1/2" x 4"	Galvanized	50	085 102 1
5/8" x 5"	Galvanized	20	085 122 1



CORNER PLATES

SIZE INS (MM)	FINISH	QTY PER BOX	CODE
2" (50)	Zinc	50	235 050 8
2 1/2" (65)	Zinc	50	235 065 8
3" (75)	Zinc	50	235 075 8
4" (100)	Zinc	25	235 100 8
5" (125)	Zinc	25	235 125 8
6" (150)	Zinc	25	235 150 8



TEE PLATES

SIZE INS (MM)	FINISH	QTY PER BOX	CODE
3" (75)	Zinc	25	236 075 8
4" (100)	Zinc	25	236 100 8



MENDING PLATES

SIZE INS (MM)	FINISH	QTY PER BOX	CODE
3" (75)	Zinc	25	237 075 8
4" (100)	Zinc	25	237 100 8
5" (125)	Zinc	25	237 125 8
6" (150)	Zinc	25	237 150 8



TABLE STRETCHER PLATES

SIZE INS (MM)	FINISH	QTY PER BOX	CODE
1 1/2" (32)	Zinc	100	238 038 8



CORNER BRACES

SIZE INS (MM)	FINISH	QTY PER BOX	CODE
1" (25)	Zinc	50	231 025 8
1 1/2" (38)	Zinc	50	231 038 8
2" (50)	Zinc	50	231 050 8
2 1/2" (65)	Zinc	50	231 065 8
3" (75)	Zinc	50	231 075 8
4" (100)	Zinc	25	231 100 8
6" (150)	Zinc	25	231 150 8
8" (200)	Zinc	25	231 200 8



Decking Accessories

A high quality range of decking and balcony accessories for use with wood.

- 6' and 8' Pre-Welded Sections
- Unique Adjustable railing panel, suits and steps or stairway
- Pre-galvanized Steel, zinc phosphate, DuPont® e-coat and premium powder coating
- 15 Year manufacturer warranty
- Virtually Maintenance free
- Allows installer to complete the project much faster, saving days of wasted journeys



FENCEMATE®

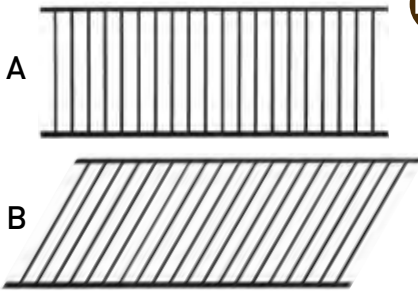

NEW

STEEL MODULAR DECKING AND BALCONY RAIL PANELS

DESCRIPTION	SIZE INS (MM)	FINISH	QTY PER BOX	CODE
Welded (A)	72" x 40" (1820 x 1020)	Black	1	825 182 3
Welded (A)	96" x 40" (2440 x 1020)	Black	1	825 244 3
Adjustable (B)	96" x 40" (2440 x 1020)	Black	1	826 244 3



NEW

COMPLETE KIT FOR MAKING GATES

SIZE INS (MM)	FINISH	QTY PER BOX	CODE
40" (1000)	Black	1	829 009 3

Modular railing panel not included



NEW

ACCENT PANEL RAIL

SIZE INS (MM)	FINISH	QTY PER BOX	CODE
96" x 5" (2440 x 125)	Black	1	828 244 3



NEW

METAL POST WITH MOUNTING KIT

SIZE INS (MM)	FINISH	QTY PER BOX	CODE
45" x 3" (1140 x 75)	Black	1	824 125 3



NEW

ANGLE ADAPTOR BRACKET

DESCRIPTION	FINISH	QTY PER BOX	CODE
Pack of 4	Black	1	829 004 3

Modular railing panel not included



NEW

FIXING BRACKET FOR RAILING PANELS

DESCRIPTION	FINISH	QTY PER BOX	CODE
Pack of 4	Black	1	829 003 3



NEW

ACCENT TOP HAND RAIL METAL

SIZE INS (MM)	FINISH	QTY PER BOX	CODE
96" (2440)	Black	1	830 244 3

CLASSIC SPINDLES

NEW

DESCRIPTION	SIZE INS (MM)	FINISH	QTY PER BOX	CODE
1.2m cover (10 spindles)	26" (660)	Black	10	820 001 0
1.2m cover (10 spindles)	32" (800)	Black	10	820 002 0



ARC SPINDLES

NEW

DESCRIPTION	SIZE INS (MM)	FINISH	QTY PER BOX	CODE
0.625m cover (5 spindles)	32" (800)	Black	5	820 008 0



BAROQUE SPINDLES

NEW

DESCRIPTION	SIZE INS (MM)	FINISH	QTY PER BOX	CODE
0.625m cover (5 spindles)	32" (800)	Black	5	820 007 0



STEEL MODULAR DECKING AND BALCONY RAIL PANELS

NEW

DESCRIPTION	SIZE INS (MM)	FINISH	QTY PER BOX	CODE
Straight	1.2m cover (10 spindles)	Black	10	820 003 0
For Stairs	1.2m cover (10 spindles)	Black	10	820 004 0



RAILING CONNECTORS (PACK OF 2)

NEW

SIZE INS (MM)	FINISH	QTY PER BOX	CODE
1 1/2" x 4" (33 x 94)	Black	1	819 000 0



ALUMINUM ANTI-SLIP PLATE

NEW

SIZE MM	FINISH	QTY PER BOX	CODE
115 x 635	Aluminum/Black	10	380 115 0
115 x 1000	Aluminum/Black	10	380 115 9
62.5 x 635	Aluminum/Black	10	380 625 0



Decking Accessories





Shed & Barn Hardware

The following pages contain a selection of hardware ranging from Simple to Elegant to suit the whole range of Basic Storage Sheds to Superior Barns.



GATEMATE



STANDARD TEE HINGES

SIZE INS (MM)	FINISH	QTY PER BOX	BULK CODE	QTY PER BOX	PRE-PACKED CODE
4" (100)	Galvanized	10/100	004 100 1	10/100	050 100 1
4" (100)	Zinc	10/100	004 100 2	10/100	050 100 2
4" (100)	Super Black	10/100	004 100 3	10/100	050 100 3
6" (150)	Galvanized	10/60	004 150 1	5/30	050 150 1
6" (150)	Zinc	10/60	004 150 2	5/30	050 150 2
6" (150)	Super Black	10/60	004 150 3	5/30	050 150 3

Galvanized hinges have brass pins. See more sizes on page 30

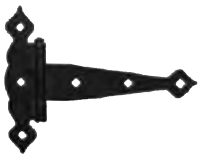

ESTATE TEE HINGES

SIZE INS (MM)	FINISH	PAIRS PER BOX	FASTENERS	CODE
8" (200)	Super Black	5/20	2" hexscrew	004 202 3

Packed in polythene sleeves - including screws. See more sizes on page 30-31



HEAVY REVERSIBLE HINGES

SIZE INS (MM)	FINISH	PAIRS PER BOX	CODE
10" (250)	Galvanized	5	509 250 1
10" (250)	Black	5	509 250 3
12" (300)	Galvanized	5	509 300 1
12" (300)	Black	5	509 300 3

See more sizes on page 3



PULL HANDLE

SIZE INS (MM)	FINISH	QTY PER BOX	CODE
8" (200)	Galvanized	10/100	147 175 1
8" (200)	Zinc	10/100	147 175 2
8" (200)	Super Black	10/100	147 175 3

Packed in polythene sleeves - including screws



LOCKING T-HANDLES

SIZE INS (MM)	FITS DOOR SIZE	FINISH	QTY PER BOX	CODE
3 1/2" (89)	1-2"	Chrome	50	800 089 4
3 1/2" (89)	1-2"	Black	50	800 089 3
4" (100)	1 3/4-2 3/4"	Chrome	50	800 100 4
4" (100)	1 3/4-2 3/4"	Black	50	800 100 3
4 1/2" (112)	2 3/4-3 3/4"	Chrome	50	800 112 4
4 1/2" (112)	2 3/4-3 3/4"	Black	50	800 112 3
5 1/2" (137)	3 3/4-4 3/4"	Chrome	50	800 137 4
5 1/2" (137)	3 3/4-4 3/4"	Black	50	800 137 3
6" (150)	4 3/4-5 3/4"	Chrome	50	800 150 4
6" (150)	4 3/4-5 3/4"	Black	50	800 150 3
6 3/4" (172)	5 3/4-6 3/4"	Chrome	50	800 162 4
6 3/4" (172)	5 3/4-6 3/4"	Black	50	800 162 3

Keyed differently. Keyed alike available.
Master key available. Includes 1 keyset,
Spare Keysets available. Does not include
inside door handle.

LOCKING L-HANDLES

SIZE INS (MM)	FITS DOOR SIZE	FINISH	QTY PER BOX	CODE
2 1/2" (62)		Chrome	50	801 062 4
3" (75)		Chrome	50	801 075 4
3 1/2" (89)	1-2"	Chrome	50	801 089 4
3 1/2" (89)	1-2"	Black	50	801 089 3
4 1/2" (112)	2 3/4-3 3/4"	Chrome	50	801 112 4
4 1/2" (112)	2 3/4-3 3/4"	Black	50	801 112 3
5 1/2" (137)	3 3/4-4 3/4"	Chrome	50	801 137 4
5 1/2" (137)	3 3/4-4 3/4"	Black	50	801 137 3

Keyed differently. Keyed alike available. Master key available. Includes 1 keyset, Spare Keysets available. Does not include inside door handle.



INSIDE DOOR HANDLE

SIZE INS (MM)	FINISH	QTY PER BOX	CODE
3 3/4" (94)	Black	100	802 094 3

Use with Locking T-Handles or Locking L-Handles.



AUTO LATCH

SIZE INS (MM)	FINISH	QTY PER BOX	CODE
2" (50)	Galvanized	10/100	601 001 1
2" (50)	Zinc	10/100	601 001 2
2" (50)	Super Black	10/100	601 001 3

Packed in polythene sleeves - including screws



TWISTED RING GATE LATCHES

SIZE INS (MM)	FINISH	QTY PER BOX	CODE
6" (150)	Galvanized	5	524 150 1
6" (150)	Black	5	524 150 3

Suitable for up to 3" thick doors or gates

For thicker applications, use Extension Spindle, page 18



LARGE DROP LATCH

SIZE INS (MM)	FINISH	QTY	CODE
10 1/2" (262)	Zinc	30	804 262 2
10 1/2" (262)	Black	30	804 262 3

Includes fasteners



HEAVY DUTY BARN LATCH

SIZE INS (MM)	PIN LENGTH	FINISH	QTY PER BOX	CODE
5" (125)	5 3/4"	Zinc	20	807 125 2
5" (125)	5 3/4"	Black	20	807 125 3



HOOK AND EYE

SIZE INS (MM)	FINISH	QTY PER BOX	CODE
4" (100)	Zinc		805 100 2

NEW





CABIN HOOKS WIRE PATTERN

SIZE INS (MM)	FINISH	QTY PER BOX	CODE
4" (100)	Galvanized	5	532 100 1
4" (100)	Black	5	532 100 3
6" (150)	Galvanized	5	532 150 1
6" (150)	Black	5	532 150 3
8" (200)	Galvanized	5	532 200 1
8" (200)	Black	5	532 200 3
12" (300)	Galvanized	5	532 300 1
12" (300)	Black	5	532 300 3



SLIDE BOLTS

SIZE INS (MM)	FINISH	QTY PER BOX	CODE
6" (150)	Galvanized	10/80	602 002 1
6" (150)	Zinc	10/80	602 002 2
6" (150)	Black	10/80	602 002 3

Packed in polythene sleeves - including screws



BARREL BOLTS

SIZE INS (MM)	FINISH	QTY PER BOX	CODE
4" (100)	Galvanized	10/100	602 100 1
4" (100)	Zinc	10/100	602 100 2
4" (100)	Black	10/100	602 100 3

Packed in polythene sleeves - including screws



SPRING LOADED BOLTS - SHORT BODY Glow in the dark handle!

SHOOT DIA INS (MM)	LENGTH INS (MM)	FINISH	QTY PER BOX	CODE
3/8" (9.5)	2 1/2" (60)	Zinc	10	110 395 2
1/2" (12)	3" (75)	Zinc	10	110 312 2

Available with Receiver Bracket (pictured on pg 8)



CHAIN BOLTS 5/8" SHOOT

SIZE INS (MM)	FINISH	QTY PER BOX	CODE
8" (200)	Zinc	5	517 200 2
8" (200)	Black	5	517 200 3



FOOT BOLTS

SIZE INS (MM)	FINISH	QTY PER BOX	CODE
8" (200)	Zinc	5	518 200 2
8" (200)	Black	5	518 200 3

SAFETY PATTERN HASPS & STAPLES

SIZE	FINISH	QTY PER BOX	CODE
4" (100)	E-Galvanized	5	533 100 2
4" (100)	Black	5	533 100 3
6" (150)	E-Galvanized	5	533 150 2
6" (150)	Black	5	533 150 3



HEAVY SAFETY PATTERN HASP & STAPLE

SIZE	FINISH	QTY PER BOX	CODE
7" (180)	Galvanized	5	138 180 1
7" (180)	Black	5	138 180 3



HEAVY HASP & STAPLES VERTICAL PATTERN

SIZE	FINISH	QTY PER BOX	CODE
6" (150)	Black	5	534 150 3
6" (150)	Galvanized	5	534 150 1



HASP & STAPLE SWIVEL HEAD

SIZE INS (MM)	FINISH	QTY PER BOX	CODE
4 1/2" (115)	Zinc	10/100	602 006 2

Packed in polythene sleeves - including screws



STRONG STAY SHELF BRACKETS

SIZE INS (MM)	FINISH	QTY PER BOX	CODE
16" x 14" (400 X 350)	Grey	10	184 400 8
18" x 16" (450 x 400)	Grey	10	184 450 8



CORNER BRACES

SIZE INS (MM)	FINISH	QTY PER BOX	CODE
1" (25)	Zinc	10/50	231 025 8
1 1/2" (38)	Zinc	10/50	231 038 8
2" (50)	Zinc	10/50	231 050 8
2 1/2" (65)	Zinc	10/50	231 065 8
3" (75)	Zinc	10/50	231 075 8
4" (100)	Zinc	5/25	231 100 8
6" (150)	Zinc	5/25	231 150 8

See braces and plates pg 36



EXHAUST VENTS

SIZE INS	FINISH	QTY PER BOX	CODE
4 x 16"	Brown	50	808 100 B
4 x 16"	White	50	808 100 W
8 x 16"	Brown	50	808 200 B
8 x 16"	White	50	808 200 W
8 x 16"	Mill	50	808 200 M





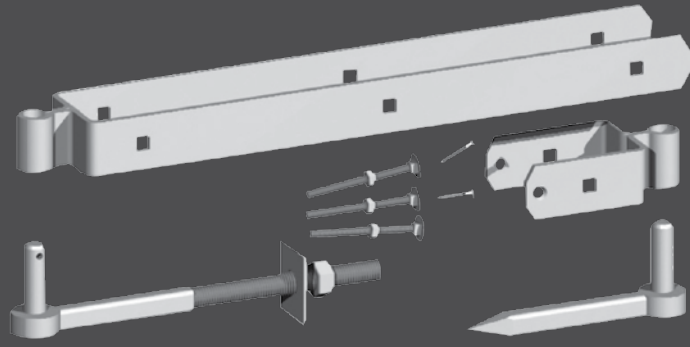

Fieldgate Hardware

This section features an impressive range of robust hardware for farm and agriculture applications. Appropriate for five bar gates or 3" thick, heavy gates.



GATEMATE[®]

Fieldgate Fittings



SPRING FASTENER SETS

SIZE INS (MM)	FINISH	QTY PER BOX	CODE
c/w Staple Catch	Galvanized	10	036 000 1
c/w Staple Catch Epoxy	Black	10	036 000 3

For installation behind post. Can operate from horseback. For 3" thick gates.

CENTRAL CLOSING GATE CATCHES

FINISH	QTY PER BOX	CODE
Galvanized	10	068 000 1

For use with the Spring Fastener Sets for latching in center of post.



HUNTING TYPE LOCKING GATE LATCHES

SIZE INS	FINISH	QTY PER BOX	CODE
17"	Galvanized	10	064 000 1

Very heavy duty

(A) Specify Double Leg Striker - 065 002 1

(B) Specify Cranked Leg Striker - 065 001 1



RISING HINGES DOUBLE STRAP BANDS & ROCKER PLATES FOR 3" GATES

SIZE INS (MM)	FINISH	QTY PER BOX	CODE
5" (125)	Galvanized	1	056 125 1

Self closing. Includes all fasteners

For 3" thick gates

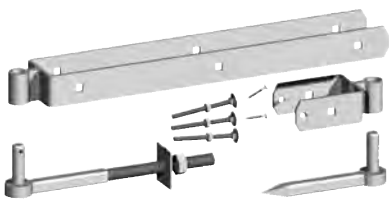

STANDARD DOUBLE STRAP HINGE SETS

SIZE INS (MM)	FINISH	QTY PER BOX	CODE
12" (300)	Galvanized	4	030 300 1
12" (300)	Black	4	030 300 3
18" (450)	Galvanized	4	030 450 1
18" (450)	Black	4	030 450 3
24" (600)	Galvanized	4	030 600 1
24" (600)	Black	4	030 600 3

Includes all fasteners. For 3" thick gates.

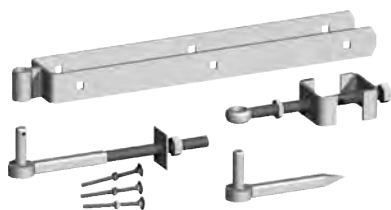

ADJUSTABLE HINGE SETS

SIZE INS (MM)	FINISH	QTY PER BOX	CODE
12" (300)	Galvanized	4	032 300 1
12" (300)	Black	4	032 300 3
18" (450)	Galvanized	4	032 450 1
18" (450)	Black	4	032 450 3
24" (600)	Galvanized	4	032 600 1
24" (600)	Black	4	032 600 3

Includes all fasteners. For 3" thick gates.

HANGER BOLTS

SIZE INS (MM)	FINISH	QTY PER BOX	CODE
1/2" X 12 (12 X 300)	Galvanized	10/30	612 121 1
1/2" X 12 (12 X 300)	Black	10/30	612 121 3
5/8" X 12 (16 X 300)	Galvanized	10/30	612 158 1
5/8" X 12 (16 X 300)	Black	10/30	612 158 3
3/4" X 12 (20 X 300)	Galvanized	10/30	612 134 1
3/4" X 12 (20 X 300)	Black	10/30	612 134 3

Comes with 2 nuts and 2 washers



HOOKS TO SCREW

PIN SIZE (MM)	SIZE INS (MM)	FINISH	QTY PER BOX	CODE
5/8" (16)	6" (150)	Galvanized	25	085 150 1
3/4" (19)	9" (250)	Galvanized	25	085 225 1



EYE BOLT

SHANK DIA (MM)	LENGTH X PIN DIA	FINISH	QTY PER BOX	CODE
1/2" (12)	4 x 1/2" (100 x 12)	Galvanized	100	049 412 1
5/8" (16)	4 X 5/8" (100 X 16)	Galvanized	50	049 416 1
5/8" (16)	6 X 5/8" (150 X 16)	Galvanized	50	049 616 1
3/4" (20)	4 X 3/4" (100 X 20)	Galvanized	25	049 420 1
3/4" (20)	6 x 3/4" (150 x 20)	Galvanized	25	049 620 1
3/4" (20)	8 x 3/4" (200 x 20)	Galvanized	25	049 820 1
3/4" (20)	10 x 3/4" (250 x 20)	Galvanized	25	049 120 1

Other sizes available

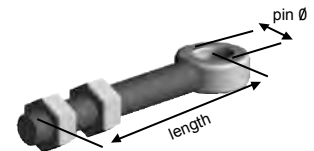

HOOKS T BUILD 19 mm PIN

SIZE INS (MM)	FINISH	QTY PER BOX	CODE
For 4 1/2" Brickwork	Galvanized	20	044 115 1
For 9" Brickwork	Galvanized	20	044 225 1



SAFETY GATE HOOK & EYES

DESCRIPTION	FINISH	QTY PER BOX	CODE
6" (150) C/W Chain & Eyes	Galvanized	5	528 150 1



ROUND RAIL LOOP LATCH

SIZE INS (MM)	FINISH	QTY PER BOX	CODE
10" (250)	Zinc	10/60	189 100 2

Post and rail fencing, heavy duty



SPLIT RAIL LOOP LATCH

SIZE INS (MM)	FINISH	QTY PER BOX	CODE
8" (200)	Zinc	10/60	188 200 2

Fasteners included



NEW

Fieldgate Fittings



CAPE COD LATCH

SIZE	FINISH	QTY PER BOX	CODE
Heavy	Galvanized	5	099 000 1
Heavy	Black	5	099 000 3

For post and rail application



THROWOVER LOOPS WITH LIFTING HANDLE FOR 3" GATES

SIZE INS (MM)	FINISH	QTY PER BOX	CODE
18" (450)	Galvanized	10	061 450 1
18" (450)	Epoxy Black	10	061 450 3



SPRING LOADED BOLTS - SHORT BODY *Glow in the dark handle!*

SHOOT DIA INS (MM)	LENGTH INS (MM)	FINISH	QTY PER BOX	CODE
3/8" (9.5)	2 1/2" (60)	E-Galvanized	10	110 395 2
1/2" (12)	3" (75)	E-Galvanized	10	110 312 2

Available with Receiver Bracket (pictured on pg 8)



SPRING LOADED ANIMAL BOLTS

SIZE INS (MM)	FINISH	QTY PER BOX	CODE
1/2" (12) dia	E-Galvanized	5	516 012 2

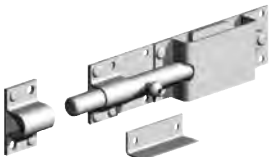

AUTOLOCK ANIMAL BOLTS

SIZE INS (MM)	FINISH	QTY PER BOX	CODE
9" (230)	Galvanized	5	515 230 1



LOCK THROUGH HOOKS - 3/4" PIN

SIZE INS (MM)	FINISH	QTY PER BOX	CODE
15" (375)	Galvanized	10	084 350 1



KICK OVER STABLE LATCHES

SIZE INS (MM)	FINISH	QTY PER BOX	CODE
9 1/2" (240)	Galvanized	5	530 240 1



SCREW HOOK AND EYE HINGE

SIZE INS	FINISH	QTY PER BOX	CODE
1/2" x 4"	Galvanized	50	085 102 1
5/8" x 5"	Galvanized	20	085 122 1

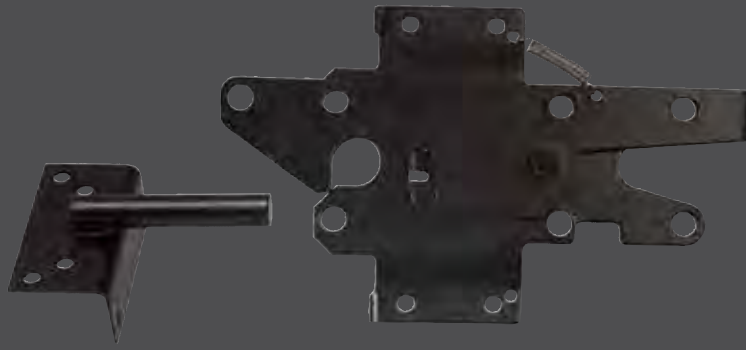

Vinyl Gate Hardware

Featuring a versatile range of gate hardware for vinyl applications as well as swimming pool enclosures, iron and chain link gates and of course our specialty, custom wood gates.



GATEMATE



AQUALATCH - POOL SAFETY LATCH

SIZE INS	FINISH	QTY PER BOX	CODE
Gate Frame Fence Post: 2" to 5"	Black	20	AQUA 20 BK



ROUND POST ADAPTER FOR CHAIN LINK (Adapter for the AquaLatch®)

SIZE INS	FINISH	QTY PER BOX	CODE
Gate Frame: 1 3/8," 1 5/8" Fence Post: 1 7/8," 2," 2 3/8," 2 5/8," 2 7/8"	Black	20	NW6149 BK



CORNERSTONE® 1 1/2" X 2" SQUARE SELF-CLOSING HINGE

SIZE INS	FINISH	PRS PER BOX	CODE
Post: 4.25"(H) x 2"(W) x 1.5"(D) Gate: 4.25"(H) x 1.45"(W) x 1.5"(D)	Black	20	CH200F SD BK



CORNERSTONE® 1 1/2" X 2" ROUND SELF-CLOSING HINGE

SIZE INS	FINISH	PRS PER BOX	CODE
Size varies	Black	20	CH200FR BK



CORNERSTONE® 3" x 3" SELF-CLOSING HINGE

SIZE INS	FINISH	PRS PER BOX	CODE
4.25"(H) x 2.88"(W) x 1.5"(D)	Black	20	CH300F SD BK



KEYSTONE® ADVANTAGE TWO-SIDED (METAL)

SIZE INS	FINISH	QTY PER BOX	CODE
Post: 2" to 6"	Black	20	KLADV M2 BK



KEYSTONE® ADVANTAGE TWO-SIDED (NYLON)

SIZE INS	FINISH	QTY PER BOX	CODE
Post: 2" to 6"	Black	20	KLADV P2 BK

KEYSTONE® E-XTERNAL MOUNT TWO-SIDED (NYLON)

SIZE INS	FINISH	QTY PER BOX	CODE
Post: 2" to 5"	Black	20	KLX P2 BK

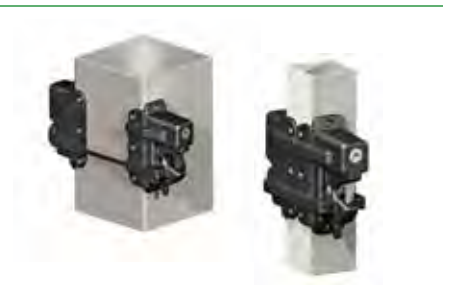

ADJUSTABLE STAINLESS STEEL SELF-CLOSING HINGE

SIZE INS	FINISH	PRS PER BOX	CODE
Post: 3.5" (H) x 3.5" (W) x 1.25" (D) Gate: 3.5" (H) x 2.75" (W) x 1.25" (D)	Black	12	NW171SCP SSB
Post: 3.5" (H) x 3.5" (W) x 1.25" (D) Gate: 3.5" (H) x 2.75" (W) x 1.25" (D)	White	12	NW171SCP SSW



STAINLESS STEEL GATE LATCH

SIZE INS	FINISH	QTY PER BOX	CODE
Post: 2" to 5"	Black	20	NW38308NUA SSB
Post: 2" to 5"	White	20	NW38308NUA SSW



Please check local pool safety codes for proper installation



*IT'S SIMPLE TO BECOME AN
AUTHORIZED GATEMATE DEALER*

- We customize planograms to any space.
- In most cases your local Gatemate rep will come and place the set.
- Free POP material and signage.

ASK ABOUT IT TODAY!



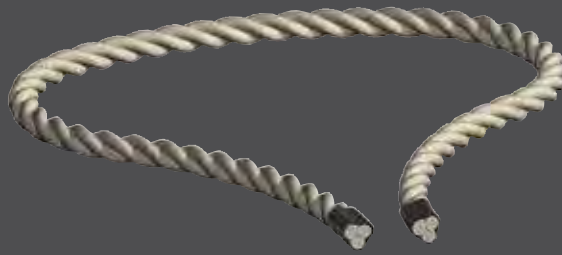

Rope Fittings

This section includes an Extensive range of rope and rope fittings. The high quality rope hardware are all solid brass, and also available with chrome plating.

FENCEMATE PRE-COILED 3 STRAND MANILA ROPE

NEW

DIAMETER INS (MM)	LENGTH FT (M)	CODE
15/16" (24)	19.6 ft (6)	860 024 0
1 1/8" (28)	19.6 ft (6)	860 028 0
15/16" (24)	26.2 ft (8)	861 024 0
1 1/8" (28)	26.2 ft (8)	861 028 0
15/16" (24)	39.3 ft (12)	862 024 0
1 1/8" (28)	39.3 ft (12)	862 028 0



FENCEMATE PRE-COILED 3 STRAND POLYHEMP ROPE

NEW

DIAMETER INS (MM)	LENGTH FT (M)	CODE
15/16" (24)	19.6 ft (6)	863 024 0
15/16" (24)	26.2 ft (8)	864 024 0
15/16" (24)	39.3 ft (12)	865 024 0





NEW ROPE EYE ON PLATE

DESCRIPTION	FINISH	QTY PER BOX	CODE
For 24 and 28mm rope	Brass	10	355 000 5
For 24 and 28mm rope	Chrome	10	355 000 C



NEW ROPE EYE ON PLATE

DESCRIPTION	FINISH	QTY PER BOX	CODE
For 24mm rope	Brass	10	359 024 5
For 24mm rope	Chrome	10	359 024 C
For 28mm rope	Brass	10	359 028 5
For 28mm rope	Chrome	10	359 028 C



NEW FENCEMATE HANDRAIL BRACKET (PACK OF 2)

DESCRIPTION	FINISH	QTY PER BOX	CODE
For 24 and 28mm rope	Brass	5	858 024 5
For 24 and 28mm rope	Chrome	5	858 024 C



NEW FENCEMATE HOOK AND EYE ON PLATE

DESCRIPTION	FINISH	QTY PER BOX	CODE
For 24mm rope	Brass	5	857 024 5
For 24mm rope	Chrome	5	857 024 C
For 28mm rope	Brass	5	857 028 5
For 28mm rope	Chrome	5	857 028 C



NEW FENCEMATE ROPE END (PACK OF 2)

DESCRIPTION	FINISH	QTY PER BOX	CODE
For 24mm rope	Brass	5	850 024 5
For 24mm rope	Chrome	5	850 024 C
For 28mm rope	Brass	5	850 028 5
For 28mm rope	Chrome	5	850 028 C



NEW ROPE END

DESCRIPTION	FINISH	QTY PER BOX	CODE
For 24mm rope	Brass	10	351 024 5
For 24mm rope	Chrome	10	351 024 C
For 28mm rope	Brass	10	351 028 5
For 28mm rope	Chrome	10	351 028 C

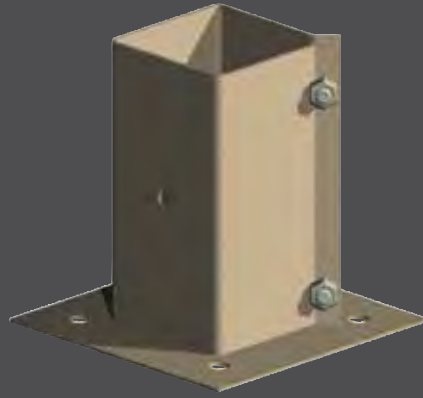

Post Support Products

Fencemate products are designed to help put up wood fencing, decking, and carports. They provide quality without hassle and ensure you produce a job that will last longer.

FENCEMATE[®]



Post Support Products



SWIFT CLAMP DRIVE IN POST SUPPORT

POST SIZE INS (MM)	LENGTH INS (MM)	FINISH	QTY PER BOX	CODE
3 1/2 x 3 1/2 (89 x 89)	30 (750)	S/Galvanized	1/8	260 090 1
3 1/2 x 3 1/2 (89 x 89)	30 (750)	E-Brown	1/8	260 090 3

Fits standard 4 x 4 post size.

These supports are suitable for most ground conditions. Robust construction ensures they will drive into very hard ground with ease and the effective clamp system will hold the post securely in the socket. Suitable for fence posts, decking, pergolas, gazebos, carports, and much more.



SWIFT CLAMP BOLT DOWN POST SUPPORT

POST SIZE INS (MM)	FINISH	QTY PER BOX	CODE
3 1/2 x 3 1/2 (89 x 89)	S/Galvanized	1/10	262 090 1
3 1/2 x 3 1/2 (89 x 89)	E-Brown	1/10	262 090 3

Fits standard 4 x 4 post size.



POST EXTENDER - SET OF 4

LENGTH INS (MM)	FINISH	SETS PER BOX	CODE
8 (200)	P/Galvanized	5/30	267 700 7

These simple cost-effective angle brackets allow any size of post to be extended up to a maximum of 3 feet. It is recommended that four are used on each post. Suitable for extending posts for trellis and decorative panels.



FENCE PIN

LENGTH INS (MM)	FINISH	QTY PER BOX	CODE
18 (450)	P/Galvanized	10/100	266 450 7

These sturdy pins are ideal for supporting path edging. They drive effectively into most ground conditions. Suitable for path edging and fence base boards.



DRIVE IN TOOL

LENGTH INS (MM)	QTY PER BOX	CODE
3" x 7 1/2"	1/10	265 100 3

This useful tool helps ensure our Drive in Post Supports are installed safely and without damage.

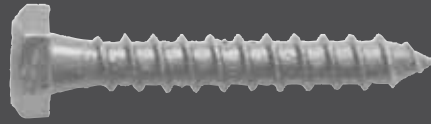

Screws & Fasteners



FENCEMATE

Screws & Fasteners



RETAIL PACK



COUNTERSUNK PHILLIPS / SQUARE DRIVE WOOD SCREWS

SIZE INS (MM)	FINISH	QTY PER BOX	CODE	RETAIL QTY/PK	RETAIL CODE
#6 x 1" (3.5 x 25)	Galvanized	1200/12K	435 008 1		
#6 x 1" (3.5 x 25)	Zinc	1200/12K	435 008 2		
#6 x 1" (3.5 x 25)	Super Black	1200/12K	435 008 3	14	R35 008 3
#8 x 1" (4.2 x 25)	Galvanized	1000/10K	435 021 1		
#8 x 1" (4.2 x 25)	Zinc	1000/10K	435 021 2		
#8 x 1" (4.2 x 25)	Super Black	1000/10K	435 021 3	14	R35 021 3
#10 x 1 1/2" (4.8 x 30)	Galvanized	500/5K	435 032 1	18	STAINLESS STEEL R35 032 6
#10 x 1 1/2" (4.8 x 30)	Zinc	500/5K	435 032 2		
#10 x 1 1/2" (4.8 x 30)	Super Black	500/5K	435 032 3	18	R35 032 3
#10 x 2" (4.8 x 50)	Galvanized	400/4K	435 034 1	18	STAINLESS STEEL R35 034 6
#10 x 2" (4.8 x 50)	Zinc	400/4K	435 034 2		
#10 x 2" (4.8 x 50)	Super Black	400/4K	435 034 3	18	R35 034 3
#12 x 2" (5.5 x 50)	Galvanized	300/3K	435 044 1	18	STAINLESS STEEL R35 044 6
#12 x 2" (5.5 x 50)	Zinc	300/3K	435 044 2		
#12 x 2" (5.5 x 50)	Super Black	300/3K	435 044 3	18	R35 044 3
#14 x 2 1/2" (6 x 60)	Galvanized	200/2k	435 050 1	18	R35 050 1
#14 x 2 1/2" (6 x 60)	Zinc	200/2K	435 050 2		
#14 x 2 1/2" (6 x 60)	Super Black	200/2K	435 050 3	18	R35 050 3

HEX SCREWS

SIZE INS (MM)	FINISH	QTY PER BOX	CODE	RETAIL QTY/PK	RETAIL CODE
1/4" x 2" (6 x 50)	Galvanized	200/2K	H06 050 1	18	R06 050 1
1/4" x 2" (6 x 50)	Zinc	200/2K	H06 050 2		
1/4" x 2" (6 x 50)	Super Black	200/2K	H06 050 3	18	R06 050 3
5/16" x 2" (8 x 50)	Galvanized	100/1K	H08 050 1	18	R08 050 1
5/16" x 2" (8 x 50)	Zinc	100/1K	H08 050 2		
5/16" x 2" (8 x 50)	Super Black	100/1K	H08 050 3	18	R08 050 3
5/16" x 3" (8 x 75)	Super Black	100/1K	H08 075 3	18	R08 075 3 H

1/4" Hex up to 4" length zinc
 5/16" Hex up to 6" length zinc
 3/8" Hex up to 8" length zinc
 7/16" Hex up to 8" length zinc



CARRIAGE BOLTS

SIZE INS (MM)	FINISH	QTY PER BOX	CODE	RETAIL QTY/PK	RETAIL CODE
5/16" x 3" (8 x 75)	Super Black	200	C08 075 3	2	R08 075 3 C
3/8" x 3 7/8" (10 x 95)	Super Black	200	C10 090 3	2	R10 090 3
7/16" x 4 1/4" (12 x 110)	Galvanized	200	C12 110 1	2	
7/16" x 4 1/4" (12 x 110)	Super Black	200	C12 110 3	2	R12 110 3





Displays



PRODUCT MERCHANDISER DISPLAYS AN EXTENSIVE RANGE OF PRE-PACKED GATE HARDWARE

Item MERCH-100

Comes with signage.
All metal, high quality stand.
Adjustable bottom casters.

Stand Dimensions: 40" wide x 28" deep x 86" high.

Each Stand will display approximately 30 products (2 stands pictured). Shelves and chain dispensers available



GALVANIZED DISPLAY

SIZE INS	FINISH	CODE
32" x 24"	Galvanized	DB-02
16" x 24"	Galvanized	DB-06



32" x 24" Pictured

HEAVY ANTIQUE DISPLAY

SIZE INS	FINISH	CODE
32" x 24"	Dull Black	DB-01
16" x 24"	Dull Black	DB-05



32" x 24" Pictured

ANTIQUE ENTRYWAY DISPLAY

SIZE INS	FINISH	CODE
32" x 24"	Dull Black	DB-04
16" x 24"	Dull Black	DB-08



32" x 24" Pictured

TRADITIONAL DISPLAY

SIZE INS	FINISH	CODE
32" x 24"	Black	DB-03
16" x 24"	Black	DB-07



32" x 24" Pictured

RIM LOCK DISPLAY

SIZE INS	FINISH	CODE
24" x 32"	Dull Black	RLD



WORKING DISPLAY - PAINTED

SIZE INS	FINISH	CODE
22" x 27 1/2"	White	NDP



WORKING DISPLAY - STAINED

SIZE INS	FINISH	CODE
22" x 27 1/2"	Stained	WDS



STAINLESS STEEL DISPLAY

SIZE INS	FINISH	CODE
32" x 24"	Stainless Steel	DB-09
16" x 24"	Stainless Steel	DB-10



Includes Stainless Steel fasteners

SCREW DISPLAY

SIZE INS	FINISH	CODE
24" x 14"	Varies	SCREW-100



WROUGHT IRON GATE DISPLAY

SIZE INS	FINISH	CODE
	Black	WIGD



**Ask
about our
Custom
Display
Program**



MARKETING MATERIAL AVAILABLE UPON REQUEST

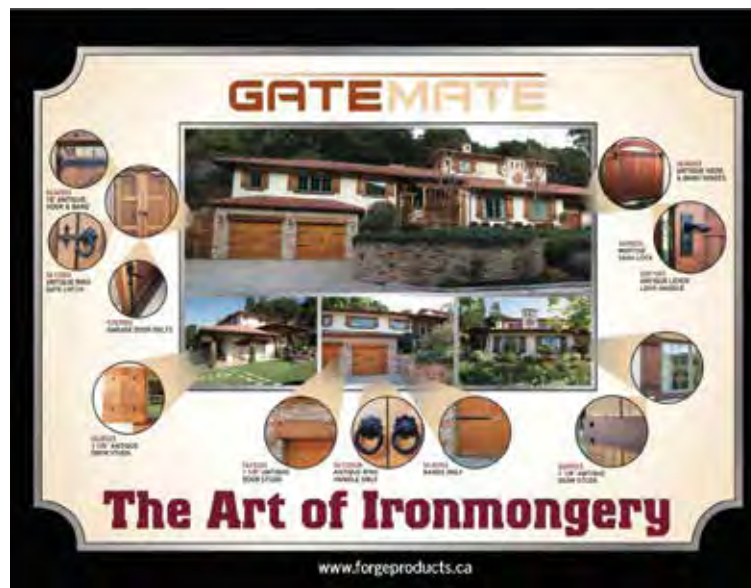

ANTI SAG KIT	35	HANDLES, continued		LATCHES, continued	
ANTI SLIP PLATE	39	Twisted Ring Handle	7	Vinyl Latches	52, 53
BELL		HAND RAIL BRACKETS	8	Windsor Latches	6, 13
Antique Bell Push	20	HANGER BOLTS	49	LOCKS	
Antique Dinner	18	J Bolt Hangers	34	Brass Padlocks	22
BOLTS		Hooks to Build	49	Gate and Door Locks	22
Antique Drop Rod	20	Hooks to Screw	49	Locking L Handle	43
Antique Straight Door Bolt	17	HASPS	10, 35, 45	Locking T Handle	42
Auto lock Animal Bolts	50	HINGE FRONTS		Long Throw Rim Locks	23
Barrel Bolts	34	Antique Hinges Fronts	16, 17	Mortise Sash Locks	17
Brenton Padbolts	4, 12	Traditional Hinge Fronts	3	Padlock Eyes	22
Cane Bolts	32	HINGES		Padlock Protector	22
Chain Bolt	44	Adjustable Bands & Hooks	3, 12	Vinyl Locks	52, 53
Foot Bolt	44	Adjustable Hinge Sets	48	MARKETING MATERIAL	65
Garage Door Bolts	5, 13	Antique Butterfly Hinges	16	MENDING PLATES	36
Heavy Cross Pattern Bolts	4	Antique Colonial Hinges	16	POOL GATE HARDWARE	51
Oval Padbolts	5	Antique FDL Hinges	16	POST SUPPORT PRODUCTS	58
Slide Bolts	31, 44	Antique Hook & Band	17	PULLS- see HANDLES	
Spring Loaded Bolts	44, 50	Antique Tee Hinges	16	QUICK REPAIR LINKS	9
Tower Bolts	5	Antique Unequal Hinges	16	RAILINGS	38
BRACKETS	9	Butt Hinges	4, 31	RINGS ON HD PLATES	8
CARBINE HOOKS	8	Cranked Bands & Hooks	2, 12	ROPE	55
CANE BOLTS – see BOLTS		Curved Rail Hinges	4	ROPE ACCESSORIES	56
CASEMENT STAY, Antique	17	Estate Self Closing Hinge	31	SCREWS	60
CLAVOS		Estate Tee Hinge	30, 42	SHELF BRACKETS	45
Antique Door Studs	20	Fancy Tee Hinge	30	SIGNS	
Antique Clavos	20	Fancy Strap Hinge	30	Beware of the Dog	20
CHAIN AND ACCESSORIES	8, 9	Heavy Reversible Hinges	3, 42	Please Shut the Gate	20
COAT HOOK		Heavy Strap Hinge	31	SPINDELS	39
Antique Coat Hook	20	Offset Hinge	30	STAINLESS 316 HARDWARE	12
CORNER BRACES	36, 45	Rising double Strap	48	STAPLES ON PLATES	8
CORNER PLATES	36	Screw Hook & Eye Hinge	36, 50	TABLE STRETCHER PLATES	36
DEE SHACKLES	9	Square Tee Hinges	30	TEE PLATES	36
DISPLAYS	62-64	Straight Bands & Hooks	2	TURN BUCKLES	8
DOOR BELL PUSH, Antique	20	Standard Double Strap	48	VENTS, Exhaust	45
DOOR GRILLS	19	Strong Tee Hinges	2, 12	VINYL GATE HARDWARE	52-53
DOOR KNOCKERS	19	Tee Hinges	30, 42	WHEELS	35
DOOR STOPS		Vinyl Hinges	52, 53		
Door Gate Stops	6	HOOK AND EYE	43, 49		
DOOR STUDS – See CLAVOS		HOOKS ON PLATES	8		
DROP ROD – see BOLTS		HOUSE NUMBERS	19		
Antique Drop Rod	20	IRON GATES	27		
EXTENSION SPINDLE	18	J BOLT HANGER – see HANGER BOLTS			
EYE BOLTS	34, 49	LATCHES			
FENCE CLIP	33	Antique Cabin Hooks	17		
GARAGE DOOR BOLTS	5, 13	Antique Lever Lock	17		
GATE BUILDING KITS		Antique Ring Gate Latch	18		
GATE CLOSERS		Antique Suffolk Latch	18		
Antique Williamsburg	20	Auto Latch	6, 32, 43		
Gas Gate Closer	34	Cabin Hooks	7, 13, 44		
Small Hydraulic Gate Closer	35	Cape Cod Latch	50		
GATE FRAMES	26	Craftsman Ring Gate Latch	7, 13		
GATE KITS	35	Floating Bar Latch	33		
GATE RETURN SPRING	34	Heavy Duty Barn Latch	34		
GATE WHEELS	35	Hook and Eye	43		
HANDLES		Kick over Stable Latches	50		
Antique Cast Ball Knob	20	Large Auto Gate Catches	6		
Antique Door Handle	18	Large Drop Latch	43		
Antique HD Door Pull	19	Lock Through Hooks	50		
Antique Lever Lock	17	Lockable Thumb Latch	33		
Antique Ring Handle	18	Looped Ring Gate Latch	33		
Antique Suffolk Handle	18	Northam Gate Latch	6		
Craftsman Ring Handle	7, 13	Optima Post Latch	33		
Door-Gate Handle	6	Post Mount Gate Latch	33		
Gate Handle	34	Round Rail Loop Latch	33, 49		
Inside Door Handle	43	Split Rail Loop latch	49		
Locking L Handle	43	Spring Fastener Sets	48		
Locking T Handle	42	Suffolk Latches	6		
Pull Handle	34, 42	Throwover Loops	50		
Rim Lock Handles	23	Top Mount Gate Latch	32		
Thumb Handle	34	Twisted Ring Gate Latch	7, 43		

TERMS OF PAYMENT

Net 30 days, F.O.B. Surrey, BC with approved credit. Customers wishing to establish a line of credit must complete the business credit application furnished by Forge Products . If Forge Products is not able to establish credit, full payment must be received before any orders can be processed.

Until Forge Products has received payment in full, Forge Products retains title to each product sold.

After 30 days from the date the products are shipped, unpaid invoices shall accrue interest at 2% per month.

RETURN POLICY

Subject to the terms of the Limited Warranty, Forge Products will replace all defective products free of charge if the item is available. Otherwise a full credit will be issued. Please contact customer service for an RGA number. All other returned goods are subject to a 20% restocking fee. Returns (including all parts & fasteners) are accepted within 60 days in original packaging and are subject to the restocking fee.

INVOICE/ORDER DISCREPANCIES

Any invoice and order discrepancies must be settled within 30 days of invoice date.

PRODUCTS COVERED AND DURATION OF WARRANTY

This Limited Warranty of Forge Products , applies to all products manufactured or distributed by Forge Products .

The term “product” means a Forge Product (or affiliate) product or device. The product purchased shall be free from defects in material and workmanship from the date of shipment by Forge Products for a period of 1 year.

Terms of the Warranty

Forge Products warrants that the product you have purchased from Forge Products is free from defects in materials and workmanship under normal use during the warranty period. The warranty period begins on the day of shipment from Forge Products . The warranty extends only to the original purchaser. It is not transferable to anyone who subsequently purchases the product from you.

During the warranty period, Forge Products will repair or replace defective parts with new parts or, at the option of Forge Products , serviceable used parts that are equivalent or superior to new parts in performance.

This Limited Warranty extends only to products purchased from Forge Products .

This Limited Warranty does not extend to any product that has been damaged or rendered defective (a) as a result of accident, misuse or abuse; (b) as a result of an act of God; (c) by operation outside the usage parameters stated herein; (d) by the use of parts not manufactured or sold by Forge Products ; (e) by modification of the product; or (f) as a result of war or terrorist attack.

EXCEPT AS EXPRESSLY SET FORTH IN THIS WARRANTY, FORGE PRODUCTS MAKES NO OTHER WARRANTIES EXPRESSED OR IMPLIED, INCLUDING ANY IMPLIED WARRANTIES OR MERCHANTABILITY AND FITNESS FOR A PARTICULAR PURPOSE. FORGE PRODUCTS EXPRESSLY DISCLAIMS ALL WARRANTIES NOT STATED IN THIS LIMITED WARRANTY. ANY IMPLIED WARRANTIES THAT MAY BE IMPOSED BY LAW ARE LIMITED TO THE TERMS OF THIS EXPRESS LIMITED WARRANTY.

DATA

Illustrations, weights and measurements supplied by Forge Products are statements of opinion and are provided for information only and form no part of the contract.



SATISFACTION GUARANTEED

We guarantee the performance and quality of every one of our products.

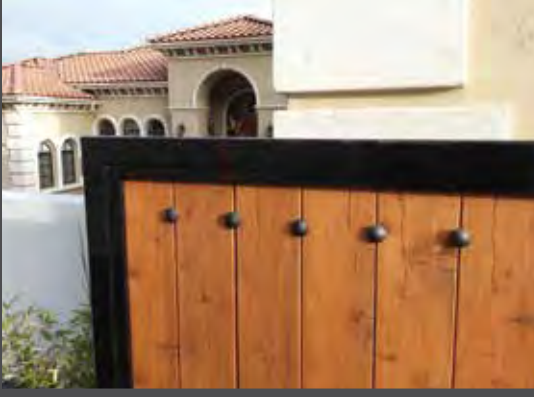

FORGE
PRODUCTS INC.

Forge Products Inc.
1 - 17530 56A Ave.
Surrey, BC V3S 1G3

T: 604 576 6084
F: 604 576 6036
E: sales@forgeproducts.ca

www.forgeproducts.ca

AUTHORIZED DISTRIBUTOR

GATEMATE

FENCEMATE